

DISTRIBUTION AMPLIFIER
5087A

ALL LIBRARIES

USNAS ATSUET, JAF

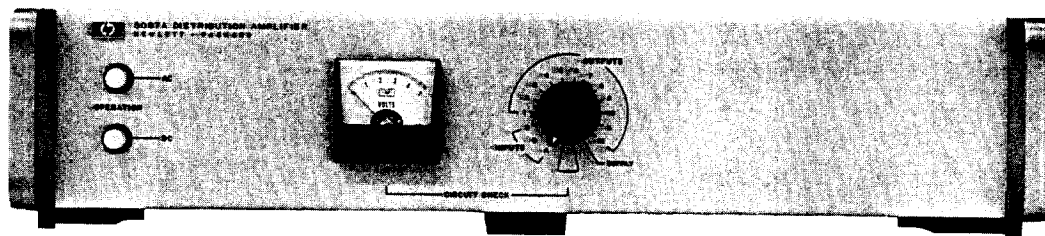

5087A

COPYRIGHT AND DISCLAIMER NOTICE

Copyright – Agilent Technologies, Inc. Reproduced with the permission of Agilent Technologies Inc. Agilent Technologies, Inc. makes no warranty of any kind with regard to this material including, but not limited to, the implied warranties of merchantability and fitness for a particular purpose. Agilent Technologies, Inc. is not liable for errors contained herein or for incidental or consequential damages in connection with the furnishing, performance, or use of this material or data.

CERTIFICATION

Hewlett-Packard Company certifies that this instrument met its published specifications at the time of shipment from the factory. Hewlett-Packard Company further certifies that its calibration measurements are traceable to the United States National Bureau of Standards, to the extent allowed by the Bureau's calibration facility, and to the calibration facilities of other International Standards Organization members.

WARRANTY AND ASSISTANCE

This Hewlett-Packard product is warranted against defects in materials and workmanship for a period of one year from the date of shipment. Hewlett-Packard will, at its option, repair or replace products which prove to be defective during the warranty period provided they are returned to Hewlett-Packard, and provided the preventive maintenance procedures in this manual are followed. Repairs necessitated by misuse of the product are not covered by this warranty. **NO OTHER WARRANTIES ARE EXPRESSED OR IMPLIED, INCLUDING, BUT NOT LIMITED TO, THE IMPLIED WARRANTIES OF MERCHANTABILITY AND FITNESS FOR A PARTICULAR PURPOSE. HEWLETT-PACKARD IS NOT LIABLE FOR CONSEQUENTIAL DAMAGES.**

Service contracts or customer assistance agreements are available for Hewlett-Packard products.

For any assistance, contact your nearest Hewlett-Packard Sales and Service Office. Addresses are provided at the back of this manual.

AKL LIBRARY

MANUAL UPDATING CHANGES

CHANGE DATE: July 1, 1991

USNAS ATSUBI, JAPAN

<p>MANUAL UPDATING COVERAGE</p> <p>This supplement adapts your manual to Serial Numbers prefixed through:</p> <p>2208</p>	<p>MANUAL IDENTIFICATION</p> <p>Instrument: HP 5087A Distribution Amplifier Operating and Service Manual</p> <p>Manual Part Number: 05087-90008 Manual Print Date: JAN 1977</p>
--	--

AKL LIBRARY

USNAS ATSUBI, JAPAN

ABOUT THIS SUPPLEMENT

The information in this supplement is provided to correct manual errors and to adapt the manual to instruments containing changes after the manual print date.

Change and correction information in this supplement is itemized by page numbers corresponding to the original manual pages. The pages in this supplement are organized in numerical order by manual page number.

HOW TO USE THIS SUPPLEMENT

Insert this title page in front of the title page in your manual.

Perform all changes specified for "All Serials", and all changes through the Series Prefix of your instrument or board.

Insert any complete replacement pages provided into your manual in the proper location.

If your manual has been updated according to the last edition of this supplement, you need only perform those changes pertaining to the new series prefix; see List of Effective Pages. New information affecting "All Serials" will be indicated by a "#" in front of the change.

LIST OF EFFECTIVE PAGES

SERIAL PREFIX, SERIAL # OR DATE CODE	PAGES
---	-------

All Serials	Between front cover and Page i, 1-3, 1-5, 3-2, 5-9, 5-10, 6-4/6-10, 8-7, 8-25, Inside Back Cover
1704A	6-9, 8-25
1732A	6-9, 8-25
1740A	6-8, 8-21
2014A	6-4
2032A	6-5, 8-7, 8-9
2120A	6-4
2208A	6-4, 6-5, 6-7, 6-8, 6-9, 8-7, 8-19

PLEASE NOTE

This instrument incorporates a new method for tracking changes to its circuit boards. Starting July 1, 1988, all circuit boards will be labeled with a unique serial number. The SERIAL number will replace the previously used SERIES number, even though there may have been no change to the circuit board. Thus, if changes were made after July 1, 1988, they will be documented in this change sheet using the new circuit board SERIAL number. Changes made before that time are documented with the SERIES number.

Therefore, Circuit changes described in this change sheet may reference either the older SERIES number or the new SERIAL number. Using both numbers enables this change sheet to support both older and newer products. To determine which changes apply to your instrument, find the instrument's serial number prefix located on the rear panel, and make the manual changes indicated in this change sheet for that serial number prefix. For example, if the serial number is 2804A12345, make changes to the manual indicated for serial prefix 2804.

SAFETY CONSIDERATIONS

The 5087A Distribution Amplifier Safety Class I instrument (provided with a protective earth terminal), designed and tested according to international safety standards. To ensure safe operation and to keep the instrument in safe condition, the user must follow the information, cautions, and warnings provided below in the Operating and Service Manual.

WARNING

Before switching on this instrument, the protective earth terminal of the instrument must be connected to the protective conductor of the (mains) power cord. The mains plug shall only be inserted in a socket outlet provided with a protective earth contact. The protective action must not be negated by the use of an extension cord (power cable) without a protective conductor (grounding).

Whenever it is likely that the protection has been impaired, the instrument must be made inoperative and be secured against any unintended operation.

All protective earth terminals, extension cords, autotransformers, and devices connected to this instrument should be connected to a protective earth grounded socket outlet. Any interruption of the protective earth grounding will cause a potential shock hazard that could result in personal injury.

For continued protection against fire hazard, replace the line fuse only with a 250V fuse of the same current rating and type. Do not use repaired fuses or short circuited fuseholders.

Before switching on this instrument, make sure that it is adapted to the voltage of the ac power source.

Any maintenance or service requiring removal of protective covers should be performed by service-trained personnel who are aware of the hazard involved (for example, fire and electrical shock).

Capacitors inside the instrument may still be charged even if the instrument has been disconnected from its source of supply.

ACOUSTIC NOISE EMISSION: LpA < 40 dB; no fan installed.
GERÄUSCHEMISSION: LpA < 40dB; Kein Ventilator eingebaut.

MANUAL CHANGES, MODEL 5087A (05087-90008)

SERIAL PREFIX, SERIAL # OR DATE CODE	CHANGES
---	---------

PAGE 1-2. GENERAL INFORMATION:

- All Serials Table 1-1. Specifications:
 - > Change NON-HARMONIC DISTORTION specifications to read:
Greater than 80dB below rated output on 100kHz, 1 MHz and 5
MHz outputs. Greater than 70dB on 10MHz outputs.

PAGE 1-5, TABLE 1-4. ASSEMBLIES USED IN THE 5087A DISTRIBUTION AMPLIFIER:

- All Serials > Change A1 Power Module from 5060-1189 to 0960-0504.

PAGE 3-2, TABLE 3-2. ASSEMBLIES USED IN THE 5087A DISTRIBUTION AMPLIFIER:

- All Serials > Change A1 Power Module from 5060-1189 to 0960-0504.

PAGE 5-8. MAINTENANCE:

- All Serials Table 5-3a. Spectrum Analyzer Control Settings
 - > Change HP8553B INPUT ATTENUATOR settings from 20dB to 30 dB in all
four columns.

PAGE 5-10. MAINTENANCE:

- All Serials Table 5-3. In-Cabinet Performance Checks
 - > Change "300u" to " 1m" in the first line of step c.

PAGE 6-4, TABLE 6-2. REPLACEABLE PARTS:

- All Serials > Replace page 6-4 with 6-4/6-4a supplied in these manual changes.
- 2014A > Delete MP18, 0403-0304 PC BOARD GUIDE.
- 2120A > Change XF1 to 2110-0564 FUSEHOLDER-BODY 12A MAX FOR UL.
 - > Add 2110-0565 FUSEHOLDER CAP 12A MAX FOR UL.
 - > Add 2110-0569 NUT-FUSEHOLDER THREAD- M 12.7 X 1.5 DBL.
- 2208A > Replace pages 6-4/6-4a with page 6-4/6-4a (SERIES 2208) supplied in these
manual changes.

Model 5087A
Replaceable Parts

Table 6-2. Replaceable Parts

Reference Designation	HP Part Number	C D	Qty	Description	Mfr Code	Mfr Part Number
5087A - SERIES 1620						
A1	0960-0504	5	1	LINE MODULE, UNFILTERED 6A 230V	05245	F2418
A2	05087-60006	3	1	BD AY, POWER SUPPLY	28480	05087-60008
A3	05087-60007	2	1	BD AY, MOTHEP	28480	05087-60007
A4	05087-60009	4	1	BD AY, CIRCUIT CHECK	28480	05087-60009
A5	05087-60004	9	1	BD AY, PREAMP (OPTS 004,031,032,033,034)	28480	05087-60004
A6	05087-60005	0	1	BD AY, 5/1 DIVIDER (OPTS 005, 034)	28480	05087-60005
A7	05087-60006	1	1	BD AY, 1/.1MHZ DIVIDER (OPTS 006,034)	28480	05087-60006
A8	05087-60001	6	1	BD AY, SMHZ AMP (OPTS 001,031,032,034)	28480	05087-60001
A9	05087-60002	0	1	BD AY, 1MHZ AMP (OPTS 002, 031,034)	28480	05087-60002
A10	05087-60003	8	1	BD AY, 100KHZ AMP (OPTS 003, 031, 034)	28480	05087-60003
A11	05087-60011	8	1	BD AY, DOUBLER (OPTION 011)	28480	05087-60011
A12	05087-60012	9	1	BD AY, 10MHZ AMP (OPTIONS 012, 033)	28480	05087-60012
A13	05087-60013	0	1	BD AY, 10/5 DIVIDER (OPTION 013)	28480	05087-60013
A14	05087-60014	1	0	BD AY, 10/1 DIVIDER	28480	05087-60014
C1	0180-2188	1	1	CAPACITOR-FXD 1500UF 50V AL-ELECTR	56289	62D10013-DFP
DS1	1450-0041		2	LAMPHOLDER ASSY, WHITE LENS	72765	5154-036-804
DS2	1450-0041		2	LAMPHOLDER ASSY, WITE LENS	72765	5154-036-804
	2140-0025		2	LAMP, INCANDESCENT 28.0V 0.04 AMPS	08806	327
	2110-0004	1	1	FUSE (INCH) .25A 250V NTD FE UL	75915	312.25
	2110-0012	1	1	FUSE (INCH) .5A 250V NTD FE UL	75915	312.500
	2110-0043	8	1	FUSE (INCH) 1.5A 250V NTD FE UL	75915	312.01.5
M1	1120-1565	1	1	METER 1.76" DIA 100UA FSD	55026	1212C
MP1	0370-0112	0	1	KNOB-BASE BAR/SKIRT 3/4" BLACK	28480	0370-0112
MP2	0340-0162	7	1	INSULATOR-TRANSISTOR TO-66 ALUM	28480	0340-0162
MP3	1250-0870	4	15	CONNECTOR-RF BNC JACK	24931	28JS112-1
MP4	5000-0050	7	2	PLATE, FLUTED ALUMINUM	28480	5000-0050
MP5	5000-8589	3	2	COVER, SIDE	28480	5000-8589
MP6	5060-0729	3	2	FRAME ASSY 3X11	28480	5060-0729
MP7	5060-0767	9	5	FOOT ASSEMBLY	28480	5060-0767
MP8	5060-8587	1	5	TOP COVER ASSEMBLY	28480	5060-8587
MP9	5060-8711	9	1	BOTTOM COVER ASSEMBLY	28480	5060-8711
MP10	5060-8739	1	1	KIT, RACK MOUNT (OPTION 908)	28480	5060-8739
MP11	3050-0005	5	2	WASHER, SHOULDER NO. 6 .14-IN-ID .375-OD	00000	ORDER BY DESCRIPTION
MP12	05087-00001	0	1	PANEL, FRONT	28480	05087-00001
MP13	05087-00002	1	5	PANEL, REAR	28480	05087-00002
MP14	05087-00003	2	1	CHASSIS-MAIN	28480	05087-00003
MP15	05087-00004	3	1	CHASSIS, POWER SUPPLY	28480	05087-00004
MP16	05087-00005	4	15	SHIELD, BOARD	28480	05087-00005
MP17	05087-00006	5	1	SHIELD-MAIN		
MP18	0403-0304		2	GUIDE, PC BOARD	28480	0403-0304
Q1	1854-0072	8	1	TRANSISTOR, NPN 2N3054 SI TO-66 PD=25W	04713	2N3054
T1	9100-3023	6	1	TRANSFORMER, POWER	28480	9100-3023
W1						
W2	8120-1378	1	1	CABLE AY, POWER	28480	8120-1378
W3	05087-60026	5	3	CABLE AY, RF 4" J1 (INPUT A)	28480	05087-60026
W4	05087-60026	5		CABLE AY, RF 4" J2 (INPUT B)	28480	05087-60026
W5	05087-60026	5		CABLE AY, RF 4" J3 (INPUT C)	28480	05087-60026
W6	05087-60027	6	6	CABLE AY, RF 5.5" J4 (OUTPUT 1)	28480	05087-60027
W7	05087-60027	6		CABLE AY, RF 5.5" J5 (OUTPUT 2)	28480	05087-60027
W8	05087-60027	6		CABLE AY, RF 5.5" J6 (OUTPUT 3)	28480	05087-60027
W9	05087-60027	6		CABLE AY, RF 5.5" J7 (OUTPUT 4)	28480	05087-60027
W10	05087-60027	6		CABLE AY, RF 5.5" J8 (OUTPUT 5)	28480	05087-60027
W11	05087-60027	6		CABLE AY, RF 5.5" J9 (OUTPUT 6)	28480	05087-60027
W12	05087-60028	7	3	CABLE AY, RF 6" J10 (OUTPUT 7)	28480	05087-60028
W13	05087-60028	7		CABLE AY, RF 6" J11 (OUTPUT 8)	28480	05087-60028
W14	05087-60028	7		CABLE AY, RF 6" J12 (OUTPUT 9)	28480	05087-60028
W15	05087-60029	8	3	CABLE AY, RF 6.6" J13 (OUTPUT 10)	28480	05087-60029
W16	05087-60029	8		CABLE AY, RF 6.6" J14 (OUTPUT 11)	28480	05087-60029
W17	05087-60029	8		CABLE AY, RF 6.6" J15 (OUTPUT 12)	28480	05087-60029

See introduction to this section for ordering information
*Indicates factory selected value

Model 5087A
Replaceable Parts

Table 6-2. Replaceable Parts

Reference Designation	HP Part Number	C D	Qty	Description	Mfr Code	Mfr Part Number
XF1	1400-0085		1	5087A - SERIES 1620 FUSEHOLDER	75915	3429004
	0360-0037	7	7	TERM-SLDR LUG PL-MTG FOP NO. 6 SCREW	78584	902-016-C
	0400-0009	9	1	GROMMET, ROUND .125-ID VINYL	01536	G250
	1251-0126	5	1	CONNECTOR-CIPC 5-PIN	71468	MS3106E14S-5S
	2190-0017	4	6	WASHER, LOCK HLCL NO. 8 .168-IN-ID	00000	ORDER BY DESCRIPTION
	2190-0022	1	4	WASHER, LOCK INTL T 3/8-IN .384-IN-ID	00000	ORDER BY DESCRIPTION
	2190-0102	8	15	WASHER, LOCK INTL T 15/32-IN .472-IN-ID	00000	ORDER BY DESCRIPTION
	2260-0009	3	4	NUT-HEX W/LKWP 4-40-THD .094-IN-THK	00000	ORDER BY DESCRIPTION
	2360-0113	2	15	SCREW-MACH .25-IN-LG PAN-HD POZI	00000	ORDER BY DESCRIPTION
	2360-0115	4	6	SCREW-MACH .312-IN-LG PAN-HD POZI	00000	ORDER BY DESCRIPTION
	2360-0121	2	3	SCREW-MACH .5-IN-LG PAN-HD-POZI	00000	ORDER BY DESCRIPTION
	2360-0181	4	8	SCREW-MACH 6-32 .25-IN-LG 82-DEG	00000	ORDER BY DESCRIPTION
	2360-0200	8	4	SCREW-MACH 6-32 .5-IN-LG 100-DEG	00000	ORDER BY DESCRIPTION
	2360-0202	0	4	SCREW-MACH 6-32 .625-IN-LG 100-DEG	00000	ORDER BY DESCRIPTION
	2420-0001	5	3	NUT-HEX W/LOKWP 6-32-THD .109-THK	00000	ORDER BY DESCRIPTION
	2510-0045	8	2	SCREW-MACH 8-32 .375-IN-LG PAN-HD POZI	00000	ORDER BY DESCRIPTION
	2510-0046	9	12	SCREW-MACH 8-32 .375-IN-LG 82-DEG	00000	ORDER BY DESCRIPTION
	2510-0101	7	4	SCREW-MACH 8-32 .312-IN-LG PAN-HD-POZI	00000	ORDER BY DESCRIPTION
	2580-0004	6	2	NUT-HEX DBL-CHAM 8-32-THD .125-IN-THK	00000	ORDER BY DESCRIPTION
	2950-0001	8	3	NUT-HEX DBL-CHAM 3/8-32-THD .094-IN-THK	00000	ORDER BY DESCRIPTION
	2950-0035	8	15	NUT-HEX DBL-CHAM 15-32-32-THD	00000	ORDER BY DESCRIPTION
	3050-0066	8	2	WASHER, FLAT MTLG NO. 6 .147-IN-ID	00000	ORDER BY DESCRIPTION
	5020-0176	0	2	INSULAT, RECEPTACLE	28480	5020-0176
	5060-0049	0	1	BD AY, 15-PIN EXTENDEP	28480	5060-0049
	7120-0539	3	3	LABEL, 5089A INPUT/OUTPUT	28480	7120-0539
	7121-3878	1	1	LABEL, FUSE RATING		
	05087-60025	4	1	CABLE, METER 26-PIN RIBBON	28480	05087-60025

See introduction to this section for ordering information
*Indicates factory selected value

Model 5087A
Replaceable Parts

Table 6-2. Replaceable Parts

Reference Designation	HP Part Number	C D	Qty	Description	Mfr Code	Mfr Part Number
5087A - SERIES 2208						
A1	0960-0504	5	1	LINE MODULE, UNFILTERED 6A 230V	05245	F2418
A2	05087-60008	3	1	BD AY, POWER SUPPLY	28480	05087-60008
A3	05087-60007	2	1	BD AY, MOTHEP	28480	05087-60007
A4	05087-60009	4	1	BD AY, CIRCUIT CHECK	28480	05087-60009
A5	05087-60004	9	1	BD AY, PREAMP (OPTS 004,031,032,033,034)	28480	05087-60004
A6	05087-60005	0	1	BD AY, 5/1 DIVIDER (OPTS 005, 034)	28480	05087-60005
A7	05087-60006	1	1	BD AY, 1/.1MHZ DIVIDER (OPTS 006,034)	28480	05087-60006
A8	05087-60001	6	1	BD AY, 5MHZ AMP (OPTS 001,031,032,034)	28480	05087-60001
A9	05087-60002	0	1	BD AY, 1MHZ AMP (OPTS 002, 031,034)	28480	05087-60002
A10	05087-60003	8	1	BD AY, 100KHZ AMP (OPTS 003, 031, 034)	28480	05087-60003
A11	05087-60011	8	1	BD AY, DOUBLER (OPTION 011)	28480	05087-60011
A12	05087-60012	9	1	BD AY, 10MHZ AMP (OPTIONS 012, 033)	28480	05087-60012
A13	05087-60013	0	1	BD AY, 10/5 DIVIDER (OPTION 013)	28480	05087-60013
A14	05087-60014	1	0	BD AY, 10/1 DIVIDER	28480	05087-60014
C1	0180-2188	1	1	CAPACITOR-FXD 1500UF 50V AL-ELECTR	56289	62D10013-DFP
DS1	1990-0534	5	2	LAMP, LED LUM INT=22MCD YELLOW	28480	1990-0534
DS2	1990-0534	5		LAMP, LED LUM INT=22MCD YELLOW	28480	1990-0534
	2110-0004	1	1	FUSE (INCH) .25A 250V NTD FE UL	75915	312.25
	2110-0012	1	1	FUSE (INCH) .5A 250V NTD FE UL	75915	312.500
	2110-0043	8	1	FUSE (INCH) 1.5A 250V NTD FE UL	75915	312.01.5
M1	1120-1565	1	1	METER 1.76" DIA 100UA FSD	55026	1212C
MP1	0370-0112	0	1	KNOB-BASE BAR/SKIRT 3/4" BLACK	28480	0370-0112
MP2	0340-0162	7	1	INSULATOR-TRANSISTOR TO-66 ALUM	28480	0340-0162
MP3	1250-0870	4	15	CONNECTOR-RF BNC JACK	24931	28JS112-1
MP4	5000-0050	7	2	PLATE, FLUTED ALUMINUM	28480	5000-0050
MP5	5000-8589	3	2	COVER, SIDE	28480	5000-8589
MP6	5060-0729	3	2	FRAME ASSY 3X11	28480	5060-0729
MP7	5060-0767	9	5	FOOT ASSEMBLY	28480	5060-0767
MP8	5060-8587	1	5	TOP COVER ASSEMBLY	28480	5060-8587
MP9	5060-8711	9	1	BOTTOM COVER ASSEMBLY	28480	5060-8711
MP10	5060-8739	1	1	KIT, RACK MOUNT (OPTION 908)	28480	5060-8739
MP11	3050-0005	5	2	WASHER, SHOULDER NO. 6 .14-IN-ID .375-00	00000	ORDER BY DESCRIPTION
MP12	05087-00001	0	1	PANEL, FRONT	28480	05087-00001
MP13	05087-00002	1	5	PANEL, REAR	28480	05087-00002
MP14	05087-00003	2	1	CHASSIS-MAIN	28480	05087-00003
MP15	05087-00004	3	1	CHASSIS, POWER SUPPLY	28480	05087-00004
MP16	05087-00005	4	15	SHIELD, BOARD	28480	05087-00005
MP17	05087-00006	5	1	SHIELD-MAIN		
MP18				NOT ASSIGNED		
Q1	1854-0072	8	1	TRANSISTOR, NPN 2N3054 SI TO-66 PD=25W	04713	2N3054
T1	9100-3023	6	1	TRANSFORMER, POWER	28480	9100-3023
W1						
W2	8120-1378	1	1	CABLE AY, POWER	28480	8120-1378
W3	05087-60026	5	3	CABLE AY, RF 4" J1 (INPUT A)	28480	05087-60026
W4	05087-60026	5		CABLE AY, RF 4" J2 (INPUT B)	28480	05087-60026
W5	05087-60026	5		CABLE AY, RF 4" J3 (INPUT C)	28480	05087-60026
W6	05087-60027	6	6	CABLE AY, RF 5.5" J4 (OUTPUT 1)	28480	05087-60027
W7	05087-60027	6		CABLE AY, RF 5.5" J5 (OUTPUT 2)	28480	05087-60027
W8	05087-60027	6		CABLE AY, RF 5.5" J6 (OUTPUT 3)	28480	05087-60027
W9	05087-60027	6		CABLE AY, RF 5.5" J7 (OUTPUT 4)	28480	05087-60027
W10	05087-60027	6		CABLE AY, RF 5.5" J8 (OUTPUT 5)	28480	05087-60027
W11	05087-60027	6		CABLE AY, RF 5.5" J9 (OUTPUT 6)	28480	05087-60027
W12	05087-60028	7	3	CABLE AY, RF 6" J10 (OUTPUT 7)	28480	05087-60028
W13	05087-60028	7		CABLE AY, RF 6" J11 (OUTPUT 8)	28480	05087-60028
W14	05087-60028	7		CABLE AY, RF 6" J12 (OUTPUT 9)	28480	05087-60028
W15	05087-60029	8	3	CABLE AY, RF 6.6" J13 (OUTPUT 10)	28480	05087-60029
W16	05087-60029	8		CABLE AY, RF 6.6" J14 (OUTPUT 11)	28480	05087-60029
W17	05087-60029	8		CABLE AY, RF 6.6" J15 (OUTPUT 12)	28480	05087-60029

See introduction to this section for ordering information
*Indicates factory selected value

Table 6-2. Replaceable Parts

Reference Designation	HP Part Number	C D	Qty	Description	Mfr Code	Mfr Part Number
XF1	5087A - SERIES 2208					
	2110-0564	8	1	FUSEHOLDER, BODY 12A MAX FOR UL	H9027	031.1657
	2110-0565	9	1	FUSEHOLDER, CAP 12A MAX FOR UL	H9027	031.1666
	2110-0569	3	2	NUT-FUSEHOLDER M12.7 BY 1.5 POLYCARB	H9027	098-0043
	0360-0037	7	7	TEMP-SLDR LUG PL-MTG FOR NO. 6 SCREW	78584	902-016-C
	0400-0009	9	1	GROMMET, ROUND .125-ID VINYL	01538	G250
	1251-0126	5	1	CONNECTOR-CIPC 5-PIN	71468	MS3106E14S-5S
	1400-0560	8	2	CLIP, LED MTD BLY POLYPRO	28480	1400-0560
	2190-0017	4	6	WASHER, LOCK HLCL NO. 8 .168-IN-ID	00000	ORDER BY DESCRIPTION
	2190-0022	1	4	WASHER, LOCK INTL T 3/8-IN .384-IN-ID	00000	ORDER BY DESCRIPTION
	2190-0102	8	15	WASHER, LOCK INTL T 15/32-IN .472-IN-ID	00000	ORDER BY DESCRIPTION
	2260-0009	3	4	NUT-HEX W/LKUP 4-40-THD .094-IN-THK	00000	ORDER BY DESCRIPTION
	2360-0113	2	15	SCREW-MACH .25-IN-LG PAN-HD POZI	00000	ORDER BY DESCRIPTION
	2360-0115	4	6	SCREW-MACH .312-IN-LG PAN-HD POZI	00000	ORDER BY DESCRIPTION
	2360-0121	2	3	SCREW-MACH .5-IN-LG PAN-HD-POZI	00000	ORDER BY DESCRIPTION
	2360-0181	4	8	SCREW-MACH 6-32 .25-IN-LG 82-DEG	00000	ORDER BY DESCRIPTION
	2360-0200	8	4	SCREW-MACH 6-32 .5-IN-LG 100-DEG	00000	ORDER BY DESCRIPTION
	2360-0202	0	4	SCREW-MACH 6-32 .625-IN-LG 100-DEG	00000	ORDER BY DESCRIPTION
	2420-0001	5	3	NUT-HEX W/LOKUP 6-32-THD .109-THK	00000	ORDER BY DESCRIPTION
	2510-0045	8	2	SCREW-MACH 8-32 .375-IN-LG PAN-HD POZI	00000	ORDER BY DESCRIPTION
	2510-0046	9	12	SCREW-MACH 8-32 .375-IN-LG 82-DEG	00000	ORDER BY DESCRIPTION
	2510-0101	7	4	SCREW-MACH 8-32 .312-IN-LG PAN-HD-POZI	00000	ORDER BY DESCRIPTION
	2580-0004	6	2	NUT-HEX DBL-CHAM 8-32-THD .125-IN-THK	00000	ORDER BY DESCRIPTION
	2950-0001	8	3	NUT-HEX DBL-CHAM 3/8-32-THD .094-IN-THK	00000	ORDER BY DESCRIPTION
	2950-0035	8	15	NUT-HEX DBL-CHAM 15-32-32-THD	00000	ORDER BY DESCRIPTION
	3050-0066	8	2	WASHER, FLAT MTLCL NO. 6 .147-IN-ID	00000	ORDER BY DESCRIPTION
	5020-0176	0	2	INSULAT, RECEPTACLE	28480	5020-0176
	5060-0049	0	1	BD AY, 15-PIN EXTENDER	28480	5060-0049
	7120-0539	3	3	LABEL, 5089A INPUT/OUTPUT	28480	7120-0539
	7121-3878	1	1	LABEL, FUSE RATING		
	05087-60025	4	1	CABLE, METER 26-PIN RIBBON	28480	05087-60025

See introduction to this section for ordering information
*Indicates factory selected value

MANUAL CHANGES, MODEL 5087A (05087-90008)

SERIAL PREFIX, SERIAL # OR DATE CODE	CHANGES
---	---------

PAGE 6-8, TABLE 6-2. A10 100kHz AMPLIFIER (05087-60003) REPLACEABLE PARTS:

- All Serials > Change A10Q1, Q2 from 1854-0019 to 1854-0477 TRANSISTOR
SIM 2N2222A.
> Change A10R7 in HP and Mfr Part Number columns to 0757-0898.
- 1740A > Add SERIES 1740 to A10 Description.
> Change A10R7 from 0757-0898 to 0757-0276 RESISTOR-FXD FLM 61.9
OHM 1% .125W TC=0+-100.
- 2208A > Add an asterisk (*) to A11C8.
> Add footnote, * FACTORY SELECTED PART.

PAGE 6-8, TABLE 6-2. A11 6MHz to 10MHz DOUBLER (05087-60011) REPLACEABLE PARTS:

- All Serials > Delete A11C8* 0141-0178 CAPACITOR
> Add A11C8* 0141-0234; CAPACITOR-FXD 500PF +-1% 300VDC MICA;
28480; 0140-0234.
> Add A11C8* 0160-0363; CAPACITOR-FXD 620PF +-1% 300VDC MICA;
28480; 0160-0363.

PAGE 6-9, TABLE 6-2. A12 10 MHz AMPLIFIER (05087-60012) REPLACEABLE PARTS:

- All Serials > Change A12Q1, Q2 from 1854-0019 to 1854-0477 TRANSISTOR-
SIM 2N2222A.
- 1704A > Change A12 SERIES to 1704.
> Add A12R16, 0757-0940 RESISTOR-FXD FLM 4700 OHM 2% 1/8W.
- 1732A > Change A12C6 quantity to 1.
> Change A12C9 to 0160-2150 CAPACITOR-FXD 33PF 5% 300 VDC.
> Change A12Q3 and Q4 to 1854-0233 TRANSISTOR S1 NPN /80131
/SN3866.
> Delete A12R16 RESISTOR-FXD FLM 4700 OHM 2% 1/8W; 24546;
C4-118-TO-4701-G.
- 2208A > Change T1, T2 from 05087-80001 to 9100-4302 TRANSFORMER
RF; 5MHZ, 14UH PRI IND.

PAGE 6-10, TABLE 6-2. A13 10-to-5 MHz DIVIDER (05087-60013) REPLACEABLE PARTS:

- All Serials > Change A13Q1, Q2 and Q4 from 1854-0019 to 1854-0477 TRANSISTOR-
SIM 2N2222A.

PAGE 6-10, TABLE 6-2. A14 10-to-1 MHz DIVIDER (05087-60014) REPLACEABLE PARTS:

- All Serials > Change A14Q1, Q2 and Q4 from 1854-0019 to 1854-0477 TRANSISTOR-
SIM 2N2222A.

MANUAL CHANGES, MODEL 5087A (05087-90008)

SERIAL PREFIX, SERIAL # OR DATE CODE	CHANGES
---	---------

PAGE 6-5, TABLE 6-2. A2 POWER SUPPLY ASSEMBLY REPLACEABLE PARTS:

- 2032A > Change A2 (05087-60008) SERIES to 2032.
> Delete A2CR4 and CR6.

- 2208A > Change A2 (05087-60008) SERIES to 2208.
> Change A2R1 to 0757-0283 RESISTOR 2K 1% .125W F TC=0+-100.
> Change A2R2 to 0757-0421 RESISTOR 825 1% .125W F TC=0+-100.

PAGE 6-5, TABLE 6-2. A3 MOTHER BOARD REPLACEABLE PARTS:

- 2032A > Change A3 (05087-60015) SERIES to 2032.
> Change A3L1 to 8159-0005 LEAD ELECT (jumper wire).

PAGE 6-5, TABLE 6-2. A4 CIRCUIT CHECK BD (05087-60009) REPLACEABLE PARTS:

- All Serials > Change A4R2 to 0757-0963 RESISTOR-FXD FLM 43K OHM 2% 1/8W;
24546; C4-1/8-TO-4302G.

PAGE 6-6, TABLE 6-2. A6 INPUT PREAMPLIFIER (05087-60005) REPLACEABLE PARTS:

- All Serials > Change A6Q1, Q2 and Q4 from 1854-0019 to 1854-0477 TRANSISTOR
SIM 2N2222A.

PAGE 6-6, TABLE 6-2. A7 1.0MHz to 100.0 kHz DIVIDER BOARD (05087-60006):

- All Serials > Change A7C12 to 01610-2331 CAPACITOR-FXD 8200PF 1%.
> Change A7C2 to 0140-0179 CAPACITOR-FXD 1000PF 300V.
> Change A7Q1, Q2, and Q4 from 1854-0019 to 1854-0477 TRANSISTOR-
SIM 2N2222A.

PAGE 6-7, TABLE 6-2. A8 5.0 MHz AMPLIFIER (05087-60001) REPLACEABLE PARTS:

- All Serials > Change A8Q1 and Q2 from 1854-0019 to 1854-0477 TRANSISTOR-
SIM 2N2222A.

- 2208A > Change T1, T2 from 05087-80001 to 9100-4302 TRANSFORM RF; 5 MHZ,
14UH PRI IND.

PAGE 6-7, TABLE 6-2. A9 1.0 MHz AMPLIFIER (05087-60002) REPLACEABLE PARTS:

- All Serials > Change A9Q1, Q2 from 1854-0019 to 1854-0477 TRANSISTOR-
SIM 2N2222A.

- 2208A > Change A9R27 from 0757-0900 to 0757-0898 RESISTOR-FXD 82 2%
.125W.

MANUAL CHANGES, MODEL 5087A (05087-90008)

SERIAL PREFIX, SERIAL # OR DATE CODE	CHANGES
---	---------

**PAGE 8-7, FIGURE 8-2. A1 POWER MODULE ASSEMBLY, A2 POWER SUPPLY ASSEMBLY,
A3 MOTHER BOARD, A4 CIRCUIT CHECK BOARD:**

- All Serials > Change A4R2 to 43K ohms.
- 2032A > Change A2 (05087-60008) SERIES to 2032.
> Delete A2CR4 and A2CR6, replace with lead elects.
- 2208A > Change A2 (05087-60008) SERIES to 2208.
> Change value of R1 to 2K.
> Change value of R2 to 825.

PAGE 8-9, FIGURE 8-3. A3 MOTHERBOARD:

- 2032A > Change A3 (05087-60007) SERIES to 2032.
> Change L1 to LEAD ELECT (jumper wire).

PAGE 8-19, FIGURE 8-8. A9 1.0 MHz AMPLIFIER BOARD:

- 2208A > Change A9R27 value from 100 ohms to 82 ohms.

PAGE 8-21, FIGURE 8-9. A10 100.0 KHz AMPLIFIER BOARD:

- 1740A > Change A10 (05087-60003) SERIES to 1740.
> Change A10R7 from 82 to 61.9 ohms.

PAGE 8-25, FIGURE 8-11. A-12 10MHz AMPLIFIER BOARD:

- All Serials > Change input terminal 5,E to read "5,E, B"
> Change input terminal 7,H to read "7,H, C"
- 1704A > Change A12 (05087-60012) SERIES to 1704.
> Add A12R16 resistor (4700 ohms) between terminals 1 and 3 of tuned
output transformer A12T2.

NOTE

Read Change for Series 1732 before adding A12R16

- 1732A > Change A12 (05087-60012) SERIES to 1732.
> Change C9 to 33 PF.

> Delete A12R16.

MANUAL CHANGES, MODEL 5087A (05087-90008)

SERIAL PREFIX, SERIAL # OR DATE CODE	CHANGES
---	---------

INSIDE BACK COVER:

All Serials

For Germany only:

> Add the following Manufacturer's Declaration inside back cover:

MANUFACTURER'S DECLARATION

NOTE	NOTE
<p>This is to certify that this product meets the radio frequency interference requirements of Directive FTZ 1046/1984. The German Bundespost has been notified that this equipment was put into circulation and has been granted the right to check the product type for compliance with these requirements.</p>	<p>Hiermit wird bescheinigt, dass dieses Gerät/System in Übereinstimmung mit den Bestimmungen von Postverfügung 1046/84 funkentstört ist.</p>
<p>Note: If test and measurement equipment is operated with unshielded cables and/or used for measurements on open setups, the user must insure that under these operating conditions, the radio frequency interference limits are met at the border of his premises.</p>	<p>Der Deutschen Bundespost wurde das Inverkehrbringen dieses Gerätes/Systems angezeigt und die Berechtigung zur Überprüfung der Serie auf Einhaltung der Bestimmungen eingeräumt.</p>
	<p>Zusatzinformation für Mess- und Testgeräte: Werden Mess- and Testgeräte mit ungeschirmten Kabeln und/oder in offenen Messaufbauten verwendet, so ist vom Betreiber sicherzustellen, dass die Funkentstörbestimmungen unter Betriebsbedingungen an seiner Grundstücksgrenze eingehalten werden.</p>

DISTRIBUTION AMPLIFIER

5087A

SERIAL PREFIX: 1620A

This manual applies directly to HP Model 5087A-Distribution Amplifiers having serial prefix 1620A.

SERIAL PREFIXES NOT LISTED

For serial prefixes greater than 1620A, a "Manual Changes" sheet is included with this manual.

OPTIONS

Information in this manual applies directly to the instrument "normal configurations" listed in Table 1-1. In addition to the "normal configurations", this manual applies to all options listed in Paragraph 1-10.

Copyright HEWLETT-PACKARD COMPANY 1973
5301 STEVENS CREEK BLVD., SANTA CLARA, CALIF. 95050

MANUAL PART NO. 05087-90008
MICROFICHE PART NO. 05087-90009

Printed: JAN 1977



TABLE OF CONTENTS

Section		Page
I	GENERAL INFORMATION	1-1
	1-1. Introduction	1-1
	1-2. Description	1-1
	1-6. Normal Configurations and Options	1-1
	1-7. Normal Configurations	1-1
	1-10. Options	1-1
	1-13. Purpose and Use of Manual	1-4
	1-15. Instrument Identification	1-4
	1-18. Accessories Furnished	1-4
	1-20. Accessories Available	1-5
II	INSTALLATION	2-1
	2-1. Unpacking and Inspection	2-1
	2-3. Storage and Shipment	2-1
	2-4. Packaging	2-1
	2-6. Environment	2-1
	2-8. Power Connections	2-1
	2-9. AC Line Voltage	2-1
	2-12. DC Line Voltage	2-2
	2-14. Operation as Bench or Rack Instrument	2-2
III	OPERATION	3-1
	3-1. General	3-1
	3-3. Turn-On	3-1
	3-5. Initial Indications After Turn-On	3-1
	3-7. Set-Up Procedure	3-1
IV	THEORY OF OPERATION	4-1
	4-1. Theory of Operation	4-1
	4-2. General	4-1
	4-7. Block Diagram Theory	4-1
	4-28. A3 Mother Board and A4 Circuit Check Board	4-5
	4-32. A5 Input Amplifier Assembly for 10 MHz, 5 MHz, 1 MHz, or 100 kHz	4-5
	4-36. A6, 5 MHz to 1 MHz Divider Assembly	4-5
	4-40. A7, 1 MHz to 100 kHz Divider Assembly	4-6
	4-44. A8, A9, A10, A12: 5 MHz, 1 MHz, 100 kHz, and 10 MHz Output Amplifiers	4-6
	4-50. A11, 5 MHz to 10 MHz Doubler Assembly	4-7
	4-55. A13, 10 MHz to 5 MHz Divider Assembly	4-7
	4-58. A14, 10 MHz to 1 MHz Divider Assembly	4-7
V	MAINTENANCE	5-1
	5-1. Introduction	5-1
	5-2. Description	5-1
	5-4. Test Equipment	5-1
	5-6. Instrument Access	5-2
	5-8. Periodic Maintenance	5-2
	5-10. Circuit Check Switch	5-2
	5-12. Operational Checks	5-2
	5-14. Troubleshooting	5-2
	5-16. Adjustments	5-2
	5-20. Regulated Power Supply Voltage	5-2
	5-22. Input Preamplifier Gain Adjustment A4R2	5-3
	5-24. Output Amplifier Adjustments	5-3
	5-27. Frequency Divider Level Adjustment A6, A7, A13, A14	5-5
	5-29. Frequency Doubler Adjustments, A11	5-6
	5-31. In-Cabinet Performance Check	5-6

TABLE OF CONTENTS (Continued)

Section		Page
VI	REPLACEABLE PARTS	6-1
	6-1. Introduction	6-1
	6-3. Ordering Information	6-1
VII	MANUAL CHANGES AND OPTIONS	7-1
	Not Used	7-1
VIII	CIRCUIT DIAGRAMS	8-1
	8-1. General	8-1
Appendix		
A	MANUAL CHANGES AND OPTIONS	A-1
	A-3. Newer Instruments	A-1
	A-5. Older Instruments	A-1
	A-7. Options	A-1

LIST OF TABLES

Table		Page
1-1.	Specifications	1-2
1-2.	Example of Decal Make-Up Showing Option 034	1-4
1-3.	Equipment Supplied	1-4
1-4.	Assemblies Used in the 5087A Distribution Amplifier	1-5
2-1.	Power Module Settings for AC Voltage Use	2-2
3-1.	Circuit Check Meter Readings	3-2
3-2.	Assemblies Used in the 5087A Distribution Amplifier	3-2
5-1.	Recommended Test Equipment	5-1
5-2.	Spectrum Analyzer Control Settings	5-4
5-3.	In-Cabinet Performance Checks	5-7
6-1.	Table of Abbreviations	6-1
6-2.	Replaceable Parts List	6-4
6-3.	Manufacturers Code List	6-11
A-1.	Changes for Older Instruments	A-2

LIST OF FIGURES

Figure		Page
1-1.	Available Configurations	1-3
2-1.	Conversion for Rack Mounting	2-2
3-1.	Configuration Label	3-1
3-2.	Front and Rear Panel Controls, Indicators, and Connectors	3-3
4-1.	5087A Block Diagram	4-2
6-1.	Mechanical Parts	6-3
8-1.	Schematic Diagrams Notes	8-2
8-2.	A1 Power Module Assembly, A2 Power Supply Assembly, A3 Mother Board, A4 Circuit Check Board	8-7
8-3.	A3 Mother Board	8-9
8-4.	A5 Input Board	8-11
8-5.	A6 5.0 MHz to 1.0 MHz Divider Board	8-13
8-6.	A7 1.0 MHz to 100.0 kHz Divider Board	8-15
8-7.	A8 5.0 MHz Amplifier Board	8-17
8-8.	A9 1.0 MHz Amplifier Board	8-19
8-9.	A10 100.0 kHz Amplifier Board	8-21
8-10.	A11 5-10 MHz Doubler Assembly	8-23
8-11.	A12 10 MHz Amplifier Board	8-25
8-12.	A13 10 MHz to 5.0 MHz Divider Board	8-27
8-13.	A14 10 MHz to 1.0 MHz Divider Board	8-29
A-1.	A5 Input Amplifier (05087-60004) Series 1240A	A-3

SECTION I

GENERAL INFORMATION

1-1. INTRODUCTION

1-2. Description

1-3. The Hewlett-Packard Model 5087A is a narrow-band amplifier capable of receiving up to four different input frequencies on three input channels. It amplifies these frequencies and supplies outputs in any selected combination on a total of 12 output lines. Table 1-4 lists the assembly designation, description, function, where it is used, the corresponding HP part number and its assigned option number.

1-4. The three input lines are labeled A, B, and C while the 12 outputs lines are labeled 1 through 12. Each input line, as well as the 12 output lines and the power supply voltage, may be monitored by a front-panel meter through a 16-position front-panel switch.

1-5. All input and output connectors and fuses are mounted on the instrument rear panel. All controls and indicators are mounted on the instrument front panel. Electrical and mechanical specifications are listed in Table 1-1 and equipment supplied is listed in Table 1-3.

1-6. NORMAL CONFIGURATIONS AND OPTIONS

1-7. Normal Configurations

1-8. There are four Normal Configurations of input and output amplifiers, which consists of the following:

- a. Option 031: Three Input Preamplifiers and four each, 5 MHz, 1 MHz, and 100 kHz Output Amplifiers.
- b. Option 032: A single Input Preamplifier and 12, 5 MHz Output Amplifiers.
- c. Option 033: A single Input Preamplifier and 12, 10 MHz Output Amplifiers.
- d. Option 034: An Input Preamplifier, one 5 MHz to 1 MHz Divider, one 1 MHz to 100 kHz Divider and four each 5 MHz, 1 MHz, and 100 kHz Output Amplifiers.

1-9. These configurations are shown by option number in Figure 1-1, a, b, c, and d.

1-10. Options

1-11. In addition to the four available, normal configuration listed in Figure 1-1, each input and output printed circuit assembly is assigned an option number. For example:

Input positions (up to 3 total):

- Option 004: Input Preamplifier (100 kHz to 10 MHz).
- Option 005: 5 MHz to 1 MHz Input Divider.
- Option 006: 1 MHz to 100 kHz Input Divider.
- Option 011: 5 MHz to 10 MHz Input Doubler.
- Option 013: 10 MHz to 5 MHz Input Divider.
- Option 014: 10 MHz to 1 MHz Input Divider.

Output positions (up to 12 total):

- Option 001: 5 MHz Output Amplifier.
- Option 002: 1 MHz Output Amplifier.
- Option 003: 100 kHz Output Amplifier.
- Option 012: 10 MHz Output Amplifier.

Table 1-1. Specifications

<p>INPUTS (Rear panel BNC)</p> <p>FREQUENCIES: 10 MHz, 5 MHz, 1 MHz, or 100 kHz. CHANNELS: Up to 3. LEVEL: 0.3 to 3.0 volts rms. INPUT IMPEDANCE: 50 ohms (1000 ohms on special order).</p> <p>OUTPUTS (Rear panel BNC)</p> <p>FREQUENCIES: 10 MHz, 5 MHz, 1 MHz, or 100 kHz. CHANNELS: Up to 12. LEVEL: 0 to 3 volts rms into a 50 ohm load (screwdriver level adjustments inside cover). HARMONIC DISTORTION: Down more than 40 dB below rated output. NON-HARMONIC DISTORTION: Down more than 80 dB below rated output. CROSSTALK (Channel-to-Channel): -60 dB or more, measured channel-to-channel.</p> <p>ISOLATION</p> <p>LOAD (Open or short on any other channel). AMPLITUDE CHANGE: <0.1 percent. PHASE CHANGE: <0.1 ns at 5 or 10 MHz. <0.5 ns at 1 MHz. <5.0 ns at 100 kHz.</p> <p>INJECTED SIGNAL: 1V signal up to 50 MHz applied to any output except 10 MHz, will be down more than 60 dB in all other outputs; 10 MHz output channel will be down more than 50 dB.</p> <p>SSB PHASE NOISE (5 MHz): More than 145 dB below signal in 1 Hz BW for frequencies greater than 1 kHz from carrier.</p> <p>SHORT TERM STABILITY DEGRADATION (5 MHz): $<1 \times 10^{-12}$ in 10 kHz band (1-second average).</p> <p>ENVIRONMENTAL</p> <p>TEMPERATURE: (MIL-E-16400, Class 4). OPERATING: 0-50°C. NON-OPERATING: -62 to +75°C.</p> <p>STABILITY:</p> <p>AMPLITUDE: ± 0.5 dB, 0 to 50°C. PHASE: <0.1 ns/°C, 5 and 10 MHz. <0.5 ns/°C, 1 MHz. <5 ns/°C, 100 kHz.</p> <p>EMC: MIL-STD-461A. HUMIDITY: 95% at 40°C. ALTITUDE: Up to 30,000 ft. SHOCK: MIL-T-21200, Class 1 and MIL-E-5400 (30 G's). VIBRATION: MIL-STD-167.</p>	<p>POWER</p> <p>AC INPUT: 115 or 230V $\pm 10\%$, 48 to 440 Hz, 20 volt amperes, max. DC INPUT: 22-30 VDC, 600 milliamperes, max.</p> <p>DIMENSIONS: 88 mm high, 425 mm wide, 286 mm dee) (3-15/32" x 16-3/4" x 11-1/4").</p> <p>WEIGHT: Typical, Option 031 — Net 15 lb (7 kg), shipping 22 lb (10 kg).</p> <p>ACCESSORIES FURNISHED: Power cord 180 cm (6 ft), detachable mating connector 1251-0126 for EXT DC input, extender board, metal decal listing input and output frequencies.</p> <p>ACCESSORIES AVAILABLE: Option 908 Rack Mounting Kit (see paragraph 1-20).</p> <p>5087A Distribution Amplifier Mainframe</p> <p>NORMAL CONFIGURATIONS (necessary input and output amplifier options included):</p> <p>Option 031: 5, 1, and 0.1 MHz inputs and 4 outputs at each frequency. Option 032: Single 5 MHz input and 12 outputs. Option 033: Single 10 MHz input and 12 outputs. Option 034: Single 5 MHz input, 4 each outputs at 5, 1, and 0.1 MHz.</p> <p>SPECIAL CONFIGURATIONS (specify individual options and quantity):</p> <p>INPUT CIRCUITS (up to 3 total):</p> <p>Option 004: Input Preamplifier (0.1 to 10 MHz). Option 005: 5 to 1 MHz Input Divider. Option 006: 1 to 0.1 MHz Input Divider. Option 011: 5 to 10 MHz Input Doubler. Option 013: 10 to 5 MHz Input Divider. Option 014: 10 to 1 MHz Input Divider.</p> <p>OUTPUT AMPLIFIER (up to 12 total):</p> <p>Option 001: 5 MHz Output Amplifier. Option 002: 1 MHz Output Amplifier. Option 003: 0.1 MHz Output Amplifier. Option 012: 10 MHz Output Amplifier.</p>
--	---

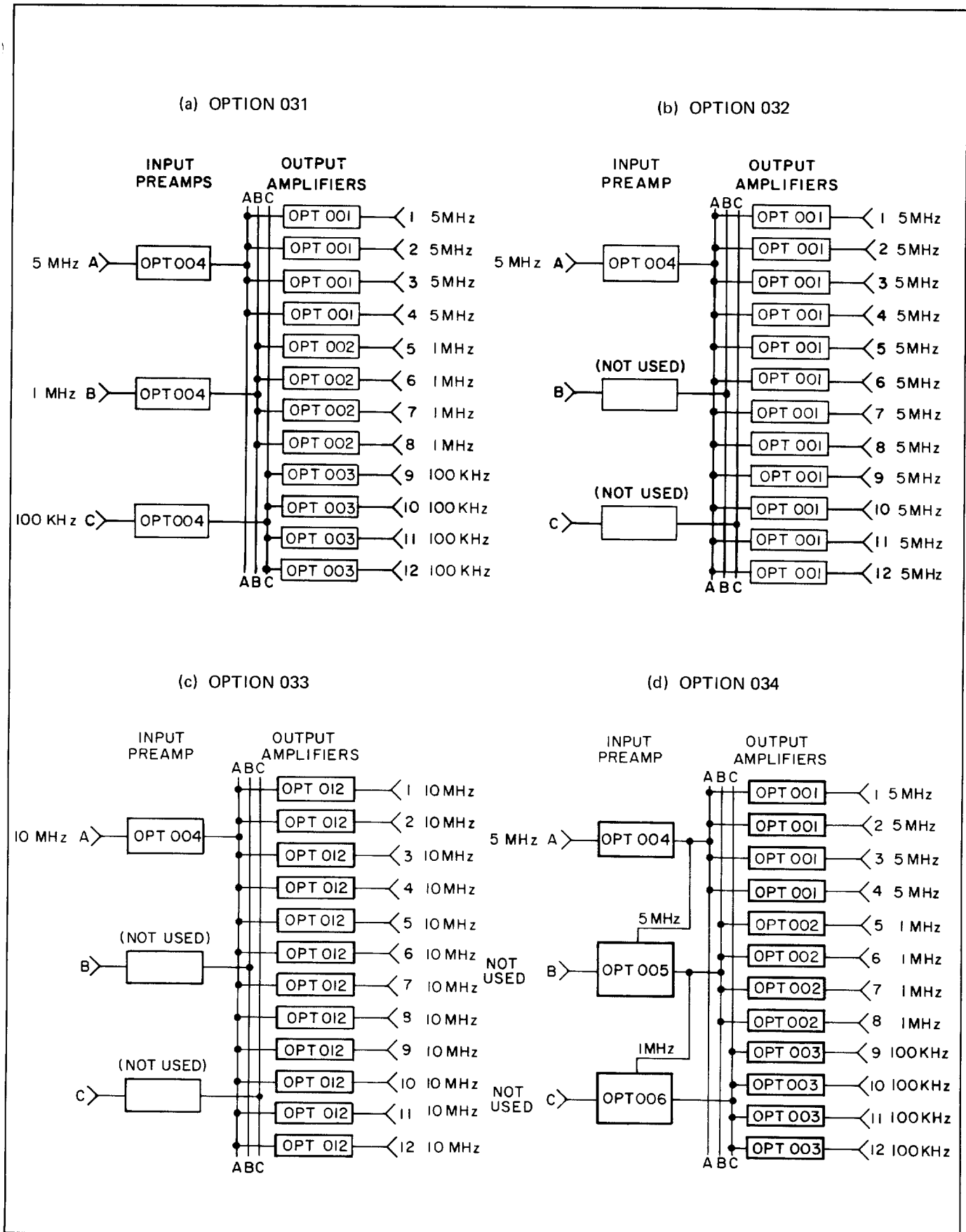

Figure 1-1. Available Configurations

1-12. Configurations which are different from Options 031 and 034 are made up on special order. The order must indicate the printed circuit board option number to be installed in each of the input and output positions. Not all positions need be filled. Two decals listing the input and output connections and frequencies are supplied with each instrument. Table 1-2 is an example of this decal and lists the make-up of Option 034.

Table 1-2. Example of Decal Make-Up Showing Option 034

Input Channel	Signal Source	Input Module	Output Channel	Frequency MHz
A	5 MHz	Input Pre-Amplifier (Option 004)	1	5
			2	5
			3	5
			4	5
	5 MHz	5 MHz to 1 MHz Divider (Option 005)	5	1
			6	1
			7	1
			8	1
	1 MHz	1 MHz to 100 kHz Divider (Option 006)	9	.1
			10	.1
			11	.1
			12	.1

1-13. PURPOSE AND USE OF MANUAL

1-14. This manual provides operating and service instructions for the 5087A Distribution Amplifier. Included are operating instructions, theory, maintenance information, parts lists, schematic diagrams, and component locators.

1-15. INSTRUMENT IDENTIFICATION

1-16. Hewlett-Packard uses a two-section, nine-digit serial number (0000A00000) tag, mounted on the rear panel to identify the instrument. The first four digits specify the instrument serial prefix, and the last five digits refer to the specific instrument. The letter which separates the four-digit group from the five-digit group identifies the country in which the instrument was manufactured.

1-17. If the serial prefix on your instrument differs from that listed in the title page of this manual, there are differences between this manual and your instrument. A manual change sheet explaining these differences is included with the manual. Contact the nearest Hewlett-Packard Sales and Service Office (listed at the rear of this manual) if this change sheet is missing.

1-18. ACCESSORIES FURNISHED

1-19. Table 1-3 lists equipment supplied.

Table 1-3. Equipment Supplied

Equipment	Description	HP Part No.
Extender Board	Allows circuit board repair out of instrument	5060-0049
AC Power Cord	180 cm (6 ft) 3-conductor with ground pin	8120-1378
Ext. DC Mating Connector	Provides capability to connect to a DC source	1251-0126
Decal	Lists inputs, outputs, channels used	7120-0539

Table 1-4. Assemblies Used in the 5087A Distribution Amplifier

Description	Function	Used in Channel(s)	Assembly Designation	Part No.	Opt. No.
Power Module	AC input power connections	---	A1	5060-1189	---
Power Supply Board	Produces dc power	---	A2	05087-60008	---
Mother Board	Interconnections	---	A3	05087-60007	---
Circuit Check Board	Provides signal paths to front-panel meter	---	A4	05087-60009	---
5 MHz Amp.	Output amp	1 to 12	A8	05087-60001	001
1 MHz Amp.	Output amp	1 to 12	A9	05087-60002	002
100 kHz Amp.	Output amp	1 to 12	A10	05087-60003	003
Input Amp. (Preamplifier)	Isolation amp	A to C	A5	05087-60004	004
5 to 1 MHz	Divider	A to C	A6	05087-60005	005
1 MHz to 100 kHz	Divider	A to C	A7	05087-60006	006
5 to 10 MHz	Doubler	A to C	A11	05087-60011	011
10 MHz Amp.	Output Amp	1 to 12	A12	05087-60012	012
10 to 5 MHz	Divider	A to C	A13	05087-60013	013
10 to 1 MHz	Divider	A to C	A14	05087-60014	014

1-20. ACCESSORIES AVAILABLE

1-21. If ordered with an instrument, Rack Mounting Kit is available as Option 908, at additional cost. When ordered separately, Rack Mounting Kit is available by ordering HP Part No. 5060-8739.

SECTION II

INSTALLATION

2-1. UNPACKING AND INSPECTION

2-2. Inspect the instrument for damage such as scratches, dents, broken knobs, etc. If the instrument is damaged or fails to operate, notify the carrier and the nearest Hewlett-Packard Sales and Service Office immediately. Retain the shipping carton and padding material for the carrier's inspection. The Sales and Service Office will arrange for the repair or replacement of the instrument without waiting for claims against the carrier to be settled.

2-3. STORAGE AND SHIPMENT

2-4. Packaging

2-5. To protect the instrument during storage or shipment, always use the best packaging methods available. Any Hewlett-Packard Sales and Service Office can provide packaging material such as that used for original factory packaging. Contract packaging companies in many cities can also provide dependable custom packaging on short notice. Here is one recommended packaging method:

- a. Wrap the instrument in a large plastic sheet or bag.
- b. Place the wrapped instrument into a "same-size" carton, or a carton which will present a "snug" fit.
- c. Seal the carton and install the boxed instrument into a final cardboard outer carton which has a 2- to 3-inch layer of loose-fill polystyrene foam or foam pellets. Fill the remainder of this outer carton with shredded or pellet foam. Close the carton, effectively seal it, and label it properly.

2-6. ENVIRONMENT

2-7. Storage and shipment environment limits are:

- a. Maximum altitude: 50,000 ft.
- b. Minimum temperature: -40°F (-40°C).
- c. Maximum temperature: $+158^{\circ}\text{F}$ ($+70^{\circ}\text{C}$).

2-8. POWER CONNECTIONS

CAUTION

Before plugging instrument into ac power line, be sure the power module slide switch on the rear panel is correctly positioned and the right fuse is installed.

2-9. AC LINE VOLTAGE

2-10. This instrument can be operated from 115 Vac or 230 Vac $\pm 10\%$ and is shipped ready for 115 Vac operation. If your ac line voltage is 230 Vac, be sure to change the POWER MODULE voltage selection switch setting and the fuse for 230 Vac operation (see Table 2-1). The input POWER MODULE is designed so that the 115V/230V switch cannot be changed unless the ac power cord is disconnected and the fuse is removed.

2-11. Change the 115V/230V switch and the fuse as follows:

- a. Disconnect power cord from the 5087A.
- b. Move sliding plastic door to left-most travel (until it covers the ac power receptacle).
- c. Pull fuse extractor handle (marked "pull") until fuse "pops" out.

- d. With fuse extractor handle pulled out, slide the 115V/230V switch (located just below the extractor handle) to the desired position (left or right).
- e. Insert correct fuse (see Table 2-1).

Table 2-1. Power Module Settings for AC Voltage Use

Slide switch set to:	115V	230V
AC line fuse	.5 Amp (HP 2110-0012)	.25 Amp (HP 2110-0004)

2-12. DC LINE VOLTAGE

2-13. When the instrument is operated from a dc source, the dc voltage must be between +22 Vdc and +30 Vdc. The rear panel dc power input connector is labeled "22-30 Vdc." A mating connector is supplied with the instrument, so a dc power cable can be made. The positive input terminal must be connected to terminal "A" and the negative input must be connected to terminal "C" which is connected to the instrument chassis. Hewlett-Packard cable 103A-16A, ordered separately, may be used to connect the Model 5087A to a Hewlett-Packard Standby Power Supply, such as the Model 5085A.

2-14. OPERATION AS BENCH OR RACK INSTRUMENT

2-15. The 5087A is shipped from the factory ready to operate as a bench instrument. Parts needed to rack mount the instrument are available as an accessory. To convert to rack mounting, refer to Figure 2-1 and do the following:

- a. Remove feet (press the foot-release button, slide foot toward center of instrument, and lift off).
- b. Remove adhesive-backed trim strips on sides, just behind front handles.
- c. Attach filler strip along bottom edge of front panel.
- d. Attach mounting brackets to sides (larger corner notch toward bottom of instrument, see Figure 2-1). The instrument is now ready to mount in standard 19-inch rack.

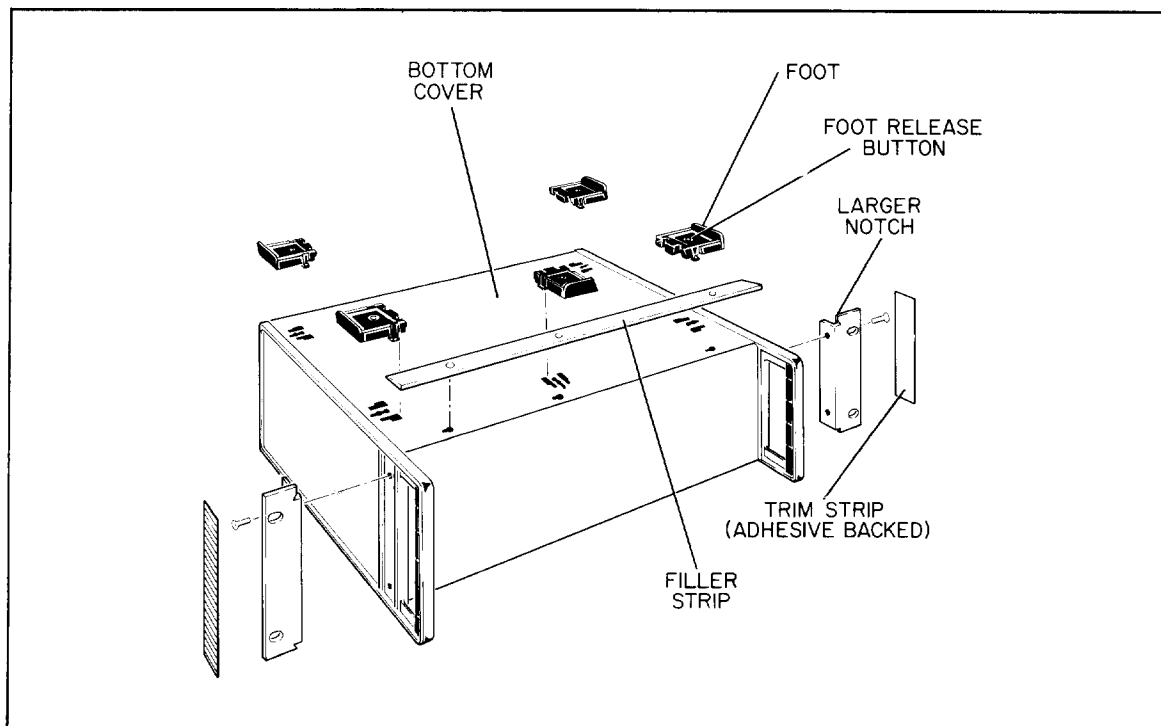

Figure 2-1. Conversion for Rack Mounting

SECTION III OPERATION

3-1. GENERAL

3-2. Operating procedures and explanations of front and rear panel controls, connectors, and indicators are provided in this section. Operating procedures involve ac or dc power connections (turn-on), connecting input signals to the input jacks, removing the top cover and adjusting the amplifiers and checking the meter readings of the various positions to verify proper operation. Table 3-2 lists assemblies which are used in the HP 5087A. Some instruments do not have certain assemblies installed. To determine your instrument's configuration, check the configuration label provided, to see which assemblies are installed in your unit. Figure 3-1 is a blank example of the label included with your instrument. It may be filled in, at this time, for future reference.

3-3. TURN-ON

3-4. There is no "ON/OFF" switch on the 5087A. Whenever ac or dc power is connected, the instrument is in operation. Ac power lights the AC lamp and dc power lights the DC lamp; when ac and dc power are used simultaneously, both lamps are "on".

3-5. Initial Indications After Turn-On

3-6. Following Turn-On, the only normal indications are: AC and/or DC lamps are lighted. CIRCUIT CHECK meter indicates 3.6 volts $\pm 2V$ in the SUPPLY position. This meter reading means that Assembly A2 is generating +18 Vdc ± 2 Vdc.

3-7. SET-UP PROCEDURE

3-8. Set-up procedure can be performed after the instrument configuration is determined.

3-9. Remove the instrument top cover. If your instrument has Input Preamplifiers installed, adjust the gain for a CIRCUIT CHECK meter reading of .3 volts.

3-10. Adjust the gain of the Output Amplifiers for a 3 Vrms reading on an R.F. voltmeter at the appropriate rear-panel OUTPUT jack.

3-11. Once these adjustments are made, the front-panel CIRCUIT CHECK meter readings should be as in Table 3-1.

INPUT CHAN.	SIGNAL SOURCE	INPUT MODULE	OUTPUT CHAN.	FREQ. MHz
			1	
			2	
			3	
			4	
			5	
			6	
			7	
			8	
			9	
			10	
			11	
			12	

Figure 3-1. Configuration Label

Table 3-1. Circuit Check Meter Readings

Circuit Check Switch Position	Meter Indication	Meaning of Meter Indication
Input A, B, C with Preamps installed	.3 volts \pm .1 volt	Signal applied to Input A, B, or C is available at the output of the Preamp and is the correct level.
Input A, B, C with divider installed	.2 to .6 volts	Signal applied to Input A, B, or C has been divided and is available at the output of the divider. Level depends on number of Output Amps being driven.
Input A, B, C with multiplier installed	.05 to .7 volts	Signal applied to Input A, B, or C has been multiplied and is available at the output of the multiplier. Level depends on number of Output Amps being driven.
Outputs 1-12	Any desired output level from 0 to 3 volts and within 10% of rear panel OUTPUT level.	Signals from INPUTS A, B, or C preamps, multiplier divider are amplified by Output Amps and available at rear-panel OUTPUT BNC's.

Table 3-2. Assemblies Used in the 5087A Distribution Amplifier

Description	Function	Used In Channels(s)	Assembly Designation	Part No.	Opt. No.
Power Module	AC input power connections	— — —	A1	5060-1189	— — —
Power Supply Board	Produces dc power	— — —	A2	05087-60008	— — —
Mother Board	Interconnections	All channels	A3	05087-60007	— — —
Circuit Check Board	Provides signal paths to front-panel meter	All channels	A4	05087-60009	— — —
5 MHz Amp.	Power amplifier	1 to 12	A8	05087-60001	001
1 MHz Amp.	Power amplifier	1 to 12	A9	05087-60002	002
100 kHz Amp.	Power amplifier	1 to 12	A10	05087-60003	003
Input Amp.	Preamplifier	A to C	A5	05087-60004	004
5 to 1 MHz	5 MHz to 1 MHz divider	A to C	A6	05087-60005	005
1 MHz to 100 kHz	1 MHz to 100 kHz divider	A to C	A7	05087-60006	006
5 to 10 MHz	5 MHz to 10 MHz doubler	A to C	A11	05087-60011	011
10 MHz Amp.	Power amplifier	1 to 12	A12	05087-60012	012
10 to 5 MHz	10 MHz to 5 MHz divider	A to C	A13	05087-60013	013
10 to 1 MHz	10 MHz to 1 MHz	A to C	A14	05087-60014	014

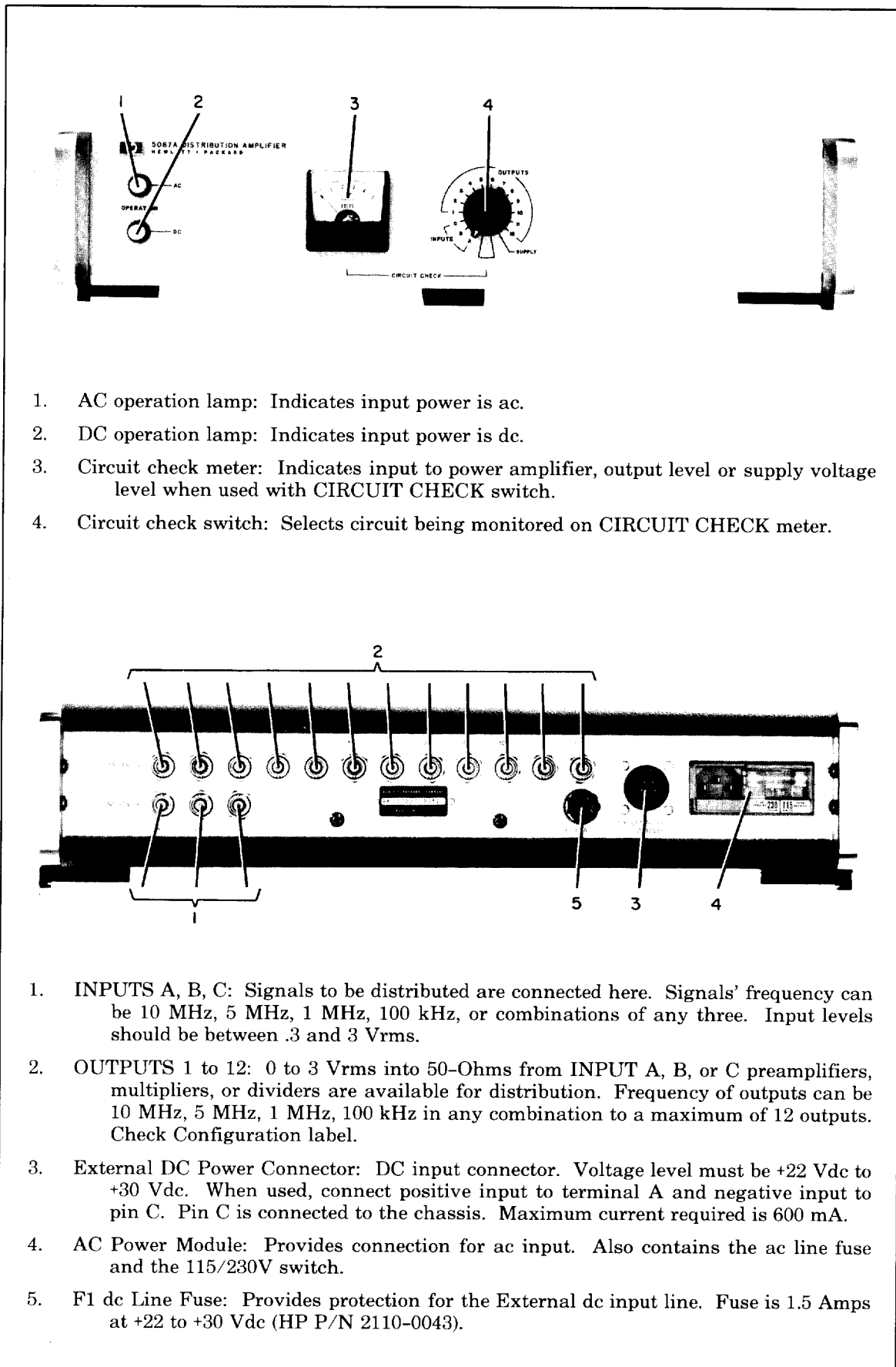

1. AC operation lamp: Indicates input power is ac.
2. DC operation lamp: Indicates input power is dc.
3. Circuit check meter: Indicates input to power amplifier, output level or supply voltage level when used with CIRCUIT CHECK switch.
4. Circuit check switch: Selects circuit being monitored on CIRCUIT CHECK meter.

1. INPUTS A, B, C: Signals to be distributed are connected here. Signals' frequency can be 10 MHz, 5 MHz, 1 MHz, 100 kHz, or combinations of any three. Input levels should be between .3 and 3 Vrms.
2. OUTPUTS 1 to 12: 0 to 3 Vrms into 50-Ohms from INPUT A, B, or C preamplifiers, multipliers, or dividers are available for distribution. Frequency of outputs can be 10 MHz, 5 MHz, 1 MHz, 100 kHz in any combination to a maximum of 12 outputs. Check Configuration label.
3. External DC Power Connector: DC input connector. Voltage level must be +22 Vdc to +30 Vdc. When used, connect positive input to terminal A and negative input to pin C. Pin C is connected to the chassis. Maximum current required is 600 mA.
4. AC Power Module: Provides connection for ac input. Also contains the ac line fuse and the 115/230V switch.
5. F1 dc Line Fuse: Provides protection for the External dc input line. Fuse is 1.5 Amps at +22 to +30 Vdc (HP P/N 2110-0043).

Figure 3-2. Front and Rear Panel Controls, Indicators, and Connectors

SECTION IV

THEORY OF OPERATION

4-1. THEORY OF OPERATION

4-2. General

4-3. The 5087A is a narrow-band amplifier which can receive up to three input frequencies on three input channels and distribute these in any combination up to a total of 12 outputs. Input frequencies can be 10 MHz, 5 MHz, 1 MHz, or 100 kHz.

4-4. The instrument is divided into two operating sections:

- a. Input Section. May contain up to three input preamplifiers, multipliers, or dividers in any combination.
- b. Output Section. May contain up to 12 output amplifiers. Output amplifiers frequencies may be 10 MHz, 5 MHz, 1 MHz, 100 kHz, or any combination of three of these frequencies.

4-5. Output signal levels from the input section are monitored by the front-panel meter. When fewer than three input sections are used, the meter indicates "0" in the unused input position.

4-6. Output amplifier levels are also monitored by the front-panel meter. Each channel output level can be displayed on the front-panel meter by setting the CIRCUIT CHECK switch to the desired position. When fewer than 12 possible outputs are used, the meter indicates only the channels being used.

4-7. BLOCK DIAGRAM THEORY (see Figure 4-1)

4-8. Four "normal configurations" exist in the 5087A. These are:

- a. OPTION 031 which receives 5 MHz, 1 MHz, 100 kHz inputs and generates four outputs at each frequency.
- b. OPTION 032 which receives a single 5 MHz input and generates 12 outputs at 5 MHz.
- c. OPTION 033 which receives a single 10 MHz input and generates 12 outputs at 10 MHz.
- d. OPTION 034 which receives a single 5 MHz input and generates four outputs at 5 MHz, 1 MHz, and 100 kHz.

4-9. Figure 4-1 shows block diagrams which are used in describing the Block Diagram Theory.

4-10. *OPTION 031. (Figure 4-1a).* Three preamplifiers and 12 Output amplifiers are used in this option. Input A receives 5 MHz; Input B, 1 MHz; and Input C, 100 kHz.

4-11. Input Preamplifiers A, B, and C isolate the input signal source from the output amplifiers. Input levels may be .3 and 3 Vrms. The gain of each input preamplifier is adjustable to a maximum of 1. When properly adjusted for a given input signal, normal output for a preamplifier is .3 volts as indicated on the front panel meter.

4-12. Preamplifier A output signal is 5 MHz and is sent to 5 MHz Output Amplifiers 1 to 4. The 5 MHz outputs from Output Amplifiers 1 to 4 can be set for an output level of 0 to 3 Vrms and are available at output BNCs 1 to 4.

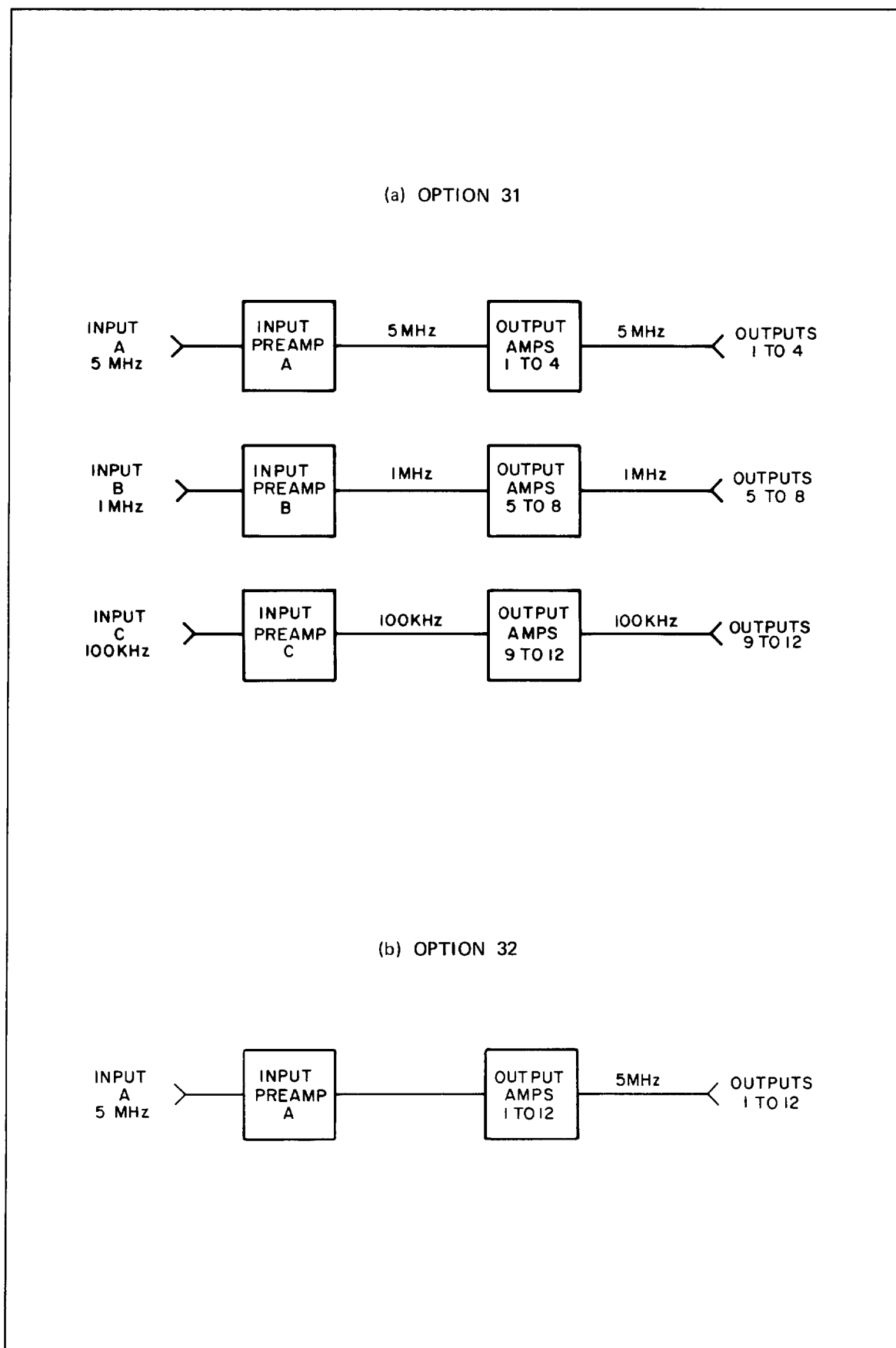

Figure 4-1. 5087A Block Diagram

4-13. Operation of Input Amplifiers B and C and Output Amplifiers 5 to 12 are the same as the 5 MHz Amplifiers, except for frequency. Input B is 1 MHz which is subsequently available at OUTPUTS 5 to 8. Input C is 100 kHz and in turn, is available at OUTPUTS 9 to 12.

4-14. *OPTION 032 (Figure 4-1b)*. A single Preamplifier and twelve 5 MHz Output Amplifiers are used in this configuration. Input A Amplifier receives the 5 MHz signal and amplifies it.

4-15. The Input Preamplifier isolates the input signal source from the output amplifiers. Input levels may be .3 to 3 Vrms. Input preamplifier gain is adjustable to a maximum gain of 1. When properly adjusted for a given input signal, normal output for a preamplifier is .3 volts as indicated on the front-panel meter.

4-16. The 5 MHz output from the Input Amplifier A is sent to twelve, 5 MHz Output Amplifiers which amplify the signals. These outputs are then available at OUTPUTS 1 to 12.

4-17. *OPTIONS 003 (Figure 4-1c)*. One Preamplifier and twelve, 10 MHz Output Amplifiers are used in this configuration. Input A Preamplifier receives the 10 MHz. Gain of Input A Amplifier is adjustable to a maximum of 1. Normal output voltage for a 1 Vrms input is .3 Volts, as indicated on the front-panel meter.

4-18. The 10 MHz output from Input Preamplifier A is sent to the twelve, 10 MHz Output Amplifiers. The amplifier outputs are available at OUTPUTS 1 to 12.

4-19. *OPTION 034 (Figure 4-1d)*. A single 5 MHz input is used to generate 5 MHz, 1 MHz, and 100 kHz outputs. The 5 MHz input is isolated by Input A Preamplifier, and sent to Output Amplifiers 1 to 4 and also to the 5 MHz-to-1 MHz Divider.

4-20. The 5 MHz is divided by the 5 MHz-to-1 MHz Divider in the Input B position. The 1 MHz is sent to Output Amplifiers 5 to 8 and also to the 1 MHz-to-100 kHz Divider.

4-21. The 1 MHz output from the 5 MHz-to-1 MHz Divider is divided again by the 1 MHz-to-100 kHz Divider in the INPUT C position. The 100 kHz from the divider is sent to Output Amplifiers 9 to 12.

4-23. *POWER MODULE (see Figure 8-2)*: Assembly A1 interfaces between the ac input and the A2 Power Supply Board and contains the 3-contact, I.E.C. approved connector, the 115V/230V switch and the ac line fuse. This module is designed to minimize hazards when changing fuses or voltage switch positions.

4-23. *POWER SUPPLY BOARD (see Figure 8-2)*. Assembly A2 generates the dc operating voltages from the ac input voltage, filters, regulates, and distributes it throughout the instrument. AC inputs from T1 are rectified by CR3 and CR5, and filtered by C1 (on chassis). AC input at A2(5) goes through R2 and lights DS1 AC OPERATION lamp. Filtered dc goes through CR4, CR6 dc blocking diodes. Two diodes are used to enhance reliability.

4-24. Unregulated dc voltage is applied to Voltage Regulator U1(7, 8) and to the collector of series regulator Q1. Voltage Regulator U1 initially allows Q1 to conduct current. The output voltage at R3, R4 junction is sensed through divider R4, 5, 6 at U1(2). U1 controls the voltage at Q1 base which controls current flow through Q1 and regulates the output voltage to the load.

4-25. The voltage drop across R3 is monitored by U1(10, 1) to provide current-limit protection. When the R3 voltage drop becomes excessive, U1 detects it and biases Q1 off. Normal operation is returned when the excessive load is removed from the power supply.

4-26. Nominal output voltage at A2(11) is +18V \pm .2V dc and is adjustable with R5. In some units, the +18V dc is also series-dropped through R7 and supplies a Zener-diode-referenced 12 \pm .2 volt supply to A2(13). This voltage is filtered through L1 and C3 and is available at A2(14). Pins 13, 14, and 15 of Assembly A2 provide voltages which can be used to power a high quality oscillator assembly such as the HP 10544A. These circuit components are found only in special units which contain an oscillator.

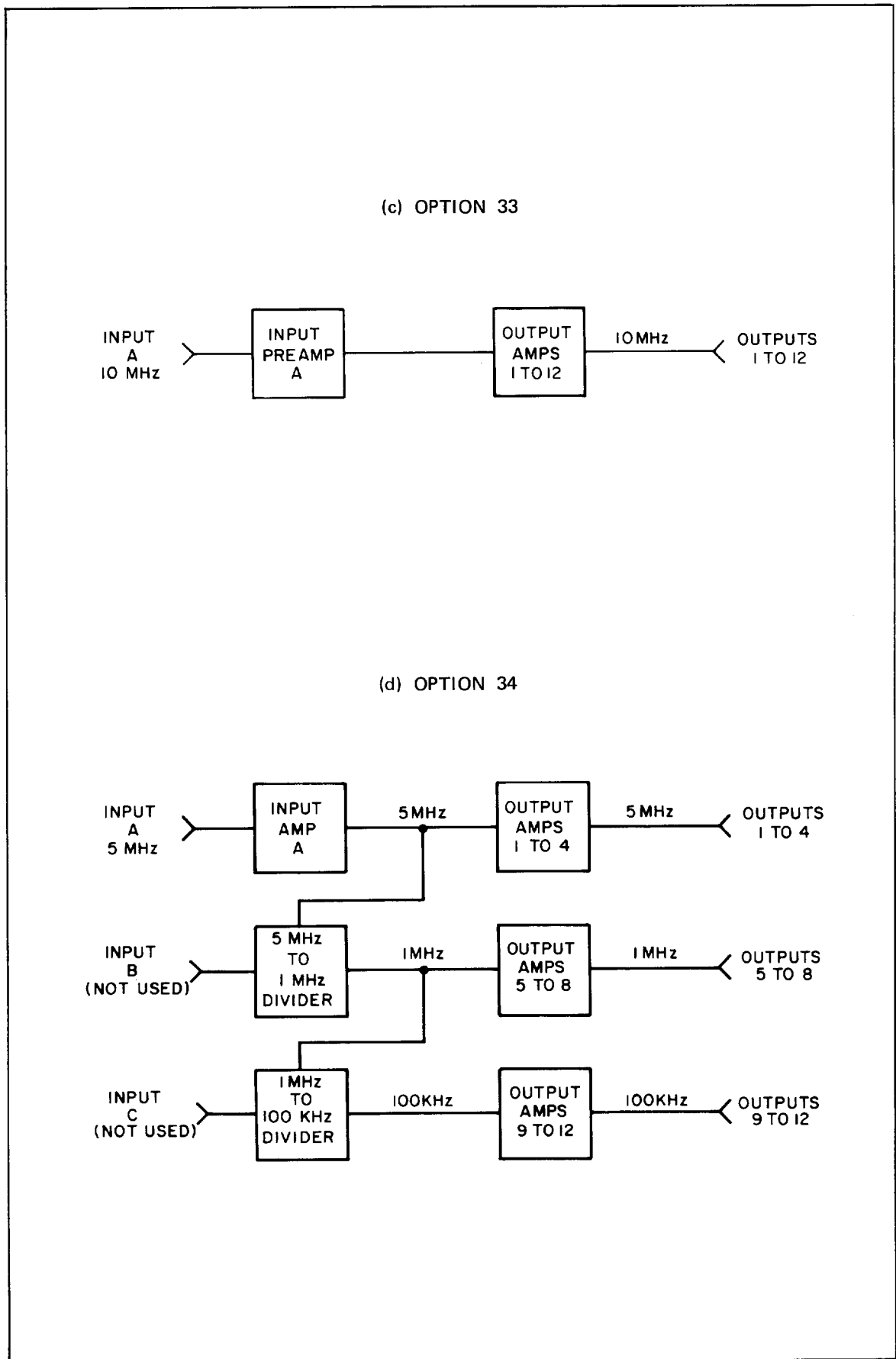

Figure 4-1. 5087A Block Diagram (Continued)

4-27. An external dc power source may be used by connecting to J16, DC POWER connector. The external dc supply must be within a +22 Vdc to +30 Vdc range. When an external dc source is connected, DC OPERATION lamp DS2 is lighted through R1. Diodes CR1, CR2 are in parallel for current-sharing and act as blocking diodes for any dc voltages generated from the ac line voltage. Regulation for the external dc occurs through U1 and Q1 in the manner described previously.

4-28. A3 MOTHER BOARD AND A4 CIRCUIT CHECK BOARD (See Figures 8-2 and 8-3)

4-29. *MOTHER BOARD*. This assembly provides mounting connectors and interconnection paths between:

- a. Input connectors (INPUT A, B, C) and input circuits (preamplifiers, multipliers, dividers).
- b. Input circuits and output amplifiers.
- c. Input circuits A, B, and C. Input circuits can multiply or divide a single input frequency to produce up to three different output frequencies.
- d. Output of amplifiers 1 through 12 and output connectors (OUTPUT 1 through OUTPUT 12).

4-30. Interconnection paths from the output pins of all the amplifiers (INPUT and OUTPUT) to the A4 CIRCUIT CHECK BOARD are also provided by the Mother Board.

4-31. *CIRCUIT CHECK BOARD*. The circuit check board is a mounting assembly for a 16-position switch. This switch allows an operator to monitor all amplifier output voltages on front-panel meter M1. Full clockwise position of this switch is the A2 Power Supply check position (SUPPLY). In this position the nominal meter reading is 3.6 volts for a +18 Vdc supply voltage.

4-32. A5 INPUT AMPLIFIER ASSEMBLY FOR 10 MHz, 5 MHz, 1 MHz, OR 100 kHz (see Figure 8-4)

4-33. Assembly A5 is a wide-band preamplifier used in the input circuit positions. It buffers the input channel and provides a 50-ohm input impedance to the instrument. It also provides a low impedance to the output amplifiers, dividers, or a multiplier. A jumper wire in the input circuit enables A5 to be used in Input A, B, or C positions.

4-34. Input signals to A5 go through R2, C1, R3, emitter-follower Q1, and through C3 to the output at A5(P,R,S). The input used depends on the jumper wire position and the input printed circuit connector used. For example, in Figure 8-3; Input A position has an input available only at pins 3,C; Input B position has inputs available at pins 3,C and 5,E.

4-35. Output signal level at C3, R7 junction is rectified by CR1, filtered by C4. The rectified output is available at A5(1,A) and displayed on front-panel CIRCUIT CHECK meter. Output level should be set by adjusting R2 to about .3 volts as indicated on the front-panel meter. Resistor R1 may be removed to change the input impedance to 1000-ohms.

4-36. A6, 5 MHz TO 1 MHz DIVIDER ASSEMBLY (see Figure 8-5)

4-37. The 5 MHz to 1 MHz Divider Assembly is normally installed in the B-Input Socket. However, it may be installed in any input socket depending on which bus is to be used for 1 MHz. 5 MHz input to this circuit may come from a preamplifier (A5), the 10 to 5 MHz divider (A13), or directly from an input jack. The signal source is determined by the input socket into which A5 assembly is installed, and by the position of the input jumper wire. For example; if the assembly is installed in the B-Input Socket, it may receive its signal from the A-Input Socket by connecting the jumper wire to pins 3,C; if the jumper wire is connected to pins 5,E the circuit will receive its signal directly from the B-Input Jack (J2).

4-38. 5 MHz signals are amplified by Q1 and sent to Q2 (base). The signal input to Q2 is limited to positive excursions by CR2. Amplified outputs from Q2 are applied to U1(1). U1 is a decade-divider operating as a divide-by-five circuit. Operating voltage for U1 is regulated, from +18 Vdc to +5 Vdc, by CR1 and Q3 and filtered by C4.

4-39. 1 MHz outputs from U1(8) are amplified by Q4. Harmonics of the 1 MHz signal are attenuated by a filter consisting of L2, L3, C7, and C8. Outputs from Q4 are transformer-coupled through pins P, R, S to the 1 MHz Output Amplifiers. The output signal is also sent through R13, rectified and filtered by CR3 and C11 and the resulting dc level at A6(1,A) is monitored by front-panel meter M1. Normal indication is .65 Volts \pm .15 Volts.

4-40. A7, 1 MHz TO 100 kHz DIVIDER ASSEMBLY (see Figure 8-6)

4-41. The 1 MHz to 100 kHz Divider Assembly is normally installed in the C-Input Socket. However, it may be installed in any of the input sockets depending on which bus is used for 100 kHz. The 1 MHz signal input to this assembly may come from a preamplifier (A5), the 5 MHz to 1 MHz divider (A6), or directly from the C-Input Jack (J3). The signal source is determined by the socket into which the assembly is installed and by the position of the input jumper wire. For example, if the assembly is installed in the C-Input Socket, it may receive its signal from the A-Input Socket by connecting the jumper to pins 3,C. The input may come from the B-Input Socket by connecting the jumper wire to pins 5,E; or the input may come directly from the C-Input Jack (J3) by connecting the jumper wire to pins 7,H.

4-42. Input signals are amplified by Q1 and sent to Q2 (base). CR2 limits Q2 input signals to positive excursions. Amplified outputs from Q2 are applied to U1(1) Decade-Divider whose output is 100 kHz. Operating voltage for U1 is regulated to +5 Vdc by CR1 and Q3 (from +18 Vdc) and filtered by C4. The filter network formed by L2, L3, C7, C8 passes the 100 kHz signal to Q4 and attenuates all other frequencies.

4-43. 100 kHz output signals from U1(12) are amplified by Q4 and transformer-coupled to the 100 kHz output amplifiers. Part of the output signal is also rectified and filtered by CR3 and C11. The resulting dc level at A7(1,A) is monitored by front-panel meter M1. Normal indication is .65 Volts \pm .15 Volts.

4-44. A8, A9, A10, A12: 5 MHz, 1 MHz, 100 kHz, AND 10 MHz OUTPUT AMPLIFIERS (see Figures 8-7, 8-8, 8-9, and 8-11)

4-45. All output amplifiers have their input terminal selectable by the position of a jumper wire on the circuit assembly. This jumper is normally installed in the position shown on the schematics for these amplifiers. However, the jumper can easily be changed to connect the input of the amplifier to the internal bus carrying the frequency, to which the amplifier is tuned. Thus, the three internally distributed frequencies within the 5087A are determined by the input frequencies, and whether preamplifiers, multipliers, or dividers are in the three input sockets. The position of the input preamplifiers, dividers, or multipliers determine which internal bus line carries which frequency. The jumper wires on the input to each output amplifier are then set so the amplifier is connected to the bus which contains that amplifiers' frequency.

4-46. Operation of all four assemblies is identical. The input signal is buffered, amplified, and emitter-coupled to a push-pull tuned output amplifier. Output level is adjustable to 3 Vrms into 50-ohms and is available at a rear-panel connector.

4-47. The input signal level to Q1 is adjusted by R1. Q1 amplifies the signal and drives emitter-follower Q2 which in turn drives push-pull amplifier Q3, Q4. Secondary winding of transformer T1 provides 180° phase-shift needed to drive Q3. The Q3, Q4 base input circuit is tuned by T1 secondary and C6. In assembly A10, an additional capacitor, C7, is also used.

4-48. Base-bias for Q3 and Q4 is derived from the forward voltage drop of CR1 (about .7 Vdc). Resistor R13, is a dc balance adjustment for Q3 and Q4, and is used to minimize second harmonic distortion in the output signal. Output signals from Q3 and Q4 are transformer-coupled through

T2 to the output jack through pins P, R, S. Output level is adjusted by R1. Maximum output voltage is 3 Vrms into 50-ohms.

4-49. The output signal level is rectified by CR2, filtered by C12, and monitored by the front-panel meter. Meter indication, for an output level of 3 Vrms, is 3 Volts \pm .3 Volts.

4-50. A11 5 MHz TO 10 MHz DOUBLER ASSEMBLY (see Figure 8-10)

4-51. Doubler Assembly A11 consists of a differential amplifier, a frequency doubler, a low-pass filter, output amplifiers, and an output impedance-matching network. One of three possible sources of 5 MHz drives the A11 Assembly. Depending on instrument configuration, the 5 MHz source is selected by moving a jumper-wire to the appropriate position.

4-52. Inputs to Q1 may originate from Input Assemblies A, B, or C, or input connectors J1, J2, or J3. These inputs terminate at A11(3,C), A11(5,E), or A11(7,H) by connecting a jumper-wire to the appropriate pad. Resistor R1 provides a 50-ohms input impedance. With R1 removed, the input impedance is 1000 ohms. Signal flow is through C2, R2, and C5 to Q1 base. Input signal level is limited by CR1, CR2. Q1 and Q2 form a differential amplifier with Q2 fixed-biased by a positive voltage at R3, R6 junction. This bias voltage is also applied through R5, to Q1 base. Signals at Q1 base are amplified by the differential action of Q1, Q2. Maximum output is obtained, from Q2, by adjusting C7.

4-53. A frequency doubler is formed by T1 and full wave rectifier CR3, CR4. The T1 secondary winding drives CR3 and the tertiary winding drives CR4. 10 MHz from CR3, CR4 is filtered through low-pass filter comprised of L3, C10, L4 and C11, coupled through C12 to Q3 base.

4-54. Output amplifiers Q3 and Q4 amplify the 10 MHz signal which is then coupled through C18 to A11 pins P, R, S. C16, C17, C18, and R15 form an impedance matching network. Part of the output signal is rectified and filtered by CR5 and C19. The resulting dc voltage at A11(1,A) is monitored by the front-panel meter M1. Normal meter indication is .05 to 1 Volt depending on output loading. Output level at A11(P,R,S) is .3V to 1V rms.

4-55. A13, 10 MHz TO 5 MHz DIVIDER ASSEMBLY (see Figure 8-12)

4-56. Input 10 MHz signals at A13(3,C), are amplified by Q1 and sent to Q2 base. Signal inputs to Q2 are limited to positive excursions by CR2. Amplified outputs from Q2 are applied to U1(14). U1 is a decade-divider operating as a divide-by-two circuit. Operating voltage for U1 is regulated to +5 Vdc by CR1 and Q3 (from +18 Vdc) and filtered by C4.

4-57. The 5 MHz output from U1(12) is amplified by Q4. Any 5 MHz harmonics are attenuated by a filter consisting of L2 and L3, and C7 and C8. Q4 output is transformer-coupled to A13(P, R, S). The output signal level is also sent through R13, rectified and filtered by CR3 and C11 and the resulting dc level at A13(1,A) is monitored by front-panel meter M1. Normal indication is about .5 Volts.

4-58. A14, 10 MHz TO 1 MHz DIVIDER ASSEMBLY (see Figure 8-13)

4-59. The 10 MHz signal input to A14 can originate from one of the input connectors or from an input amplifier such as A5 Assembly. The input signal is amplified by Q1 and sent to Q2 base. Input signals to Q2 are limited to positive excursions by CR2. The amplified output from Q2 is applied to U1(1) Decade-Divider whose output is 1 MHz. Operating voltage for U1 is regulated to +5 Vdc by CR1 and Q3 (from +18 Vdc) and filtered by C4. The filter network formed by L2, L3, C7, C8 passes the 1 MHz signal to Q4 and attenuates all other signals.

4-60. The 1 MHz signal output from U1(12) is amplified by Q4 and transformer-coupled to A14(P, R,S). Output signal level is also rectified and filtered by CR3 and C11. The resulting dc level at A14(1,A) is monitored by front-panel meter M1. Normal indication is .65 Volts \pm .15 Volts.

SECTION V MAINTENANCE

5-1. INTRODUCTION

5-2. Description

5-3. This section provides maintenance and service information for the Model 5087A Distribution Amplifier. Included are operational and performance checks, and adjustment procedures.

5-4. TEST EQUIPMENT

5-5. Recommended test equipment needed to do operational checks, performance checks, or adjustments is listed in Table 5-1. Other instruments, which have equivalent specifications, may be used.

Table 5-1. Recommended Test Equipment

Instrument	Characteristics	Recommended Type	Use
R.F. Voltmeter	Voltage Range: to 3 Vrms. Frequency Range: 10 Hz to >10 MHz $\pm 5\%$.	HP 400E	Measure Output Level.
D.C. Voltmeter	DC Range <1V to 30V 1% accuracy.	HP 412A	Set Power Supply Voltage.
Feedthru Termination	50 Ohms male and female BNC.	HP 11048B	Terminate Output under test.
Electronic Counter	Frequency: 10 MHz. Sensitivity: 50 mV rms. Accuracy: ± 1 count, \pm time base accuracy.	HP 5300A/5301A	Set Frequency of Test Oscillator.
Test Oscillator	Range: 10 Hz to 10 MHz . Output Amplitude: 3.16V max.	HP 651B	Signal Source for Performance Tests.
Step Attenuator	50 Ohms, 10 dB steps	HP 355D	Attenuate Signal to Spectrum Analyzer.
Spectrum Analyzer	Freq. Range: .1 to 110 MHz. Resp: ± 5 dB, .1 to 110 MHz. Scanwidth: 10 MHz/DIV to 20 Hz/DIV. Stability: Residual FM >60 dB for 50 Hz or more from CW signal.	HP 8553B/8552B with 141T Display	Measure Harmonic Distortion and non-harmonically related signals.
Oscilloscope	Vert. Freq. Response dc to 50 MHz. Sens: .005V/cm. Cal. Sweeps: 2 secs to .05 μ sec/cm.	HP 180A with HP 1820A and HP 1801A HP 10006A probe	Observe circuit output waveforms.

5-6. INSTRUMENT ACCESS

5-7. For access to instrument subassemblies, remove the instrument top cover. This provides access to A1 Power Module, A2 Power Supply, and A4 Circuit Check Board, and all level adjustments. Input assemblies, INPUT A, B, and C, and Output Assemblies, OUTPUT 1 through OUTPUT 12, are contained under a protective metal shield. To gain access to the assemblies, the metal shield must be removed by removing 23 screws which secure the shield to the chassis and the subassemblies.

5-8. PERIODIC MAINTENANCE

5-9. To determine if the 5087A is operating correctly or as part of a periodic maintenance program, check the readings at each switch position and/or do the operational checks or performance checks listed in Table 5-2. Periodic adjustments are not required.

5-10. CIRCUIT CHECK SWITCH

5-11. General operation of the instrument may be verified by checking each position of the front-panel CIRCUIT CHECK switch and noting the reading. Compare readings to the listings in Table 3-1, "CIRCUIT CHECK METER READINGS". The readings should be the same.

5-12. OPERATIONAL CHECKS

5-13. Checks in Table 5-2 can be used:

- a. As part of an incoming inspection to verify instrument specifications.
- b. As part of a troubleshooting procedure.
- c. After repair or adjustment, prior to returning the instrument to service.

5-14. TROUBLESHOOTING

5-15. The quickest method of troubleshooting is to check the front-panel meter readings for each of the 16 positions of the CIRCUIT CHECK switch. The normal output levels and frequencies, for those positions used, are also listed in Table 3-1.

5-16. ADJUSTMENTS

5-17. Adjustment procedures may be performed after repair, whenever an assembly is replaced, or whenever the assemblies require adjustment to maximize performance. Top cover must be removed before adjustments can be made. Check the instrument configuration (see paragraph 3-2) and signal source requirements (in the following paragraph) before making any adjustments.

5-18. To do the following tests, use the test oscillator listed in Table 5-1. Since the 5087A bandwidth is about 10% of the test frequency, set the oscillator frequency and monitor it with a frequency counter.

5-19. Check the configuration label included with the instrument (see paragraph 3-2), before doing these tests. This label lists required input frequencies, available output frequencies, and the active input and output channels.

5-20. Regulated Power Supply Voltage

5-21. A2 Power Supply Assembly provides an adjustable, regulated, output voltage adjusted for +18 Vdc. To check the A2 output voltage level or its regulation, or to adjust the output voltage level, do the following:

- a. Mount the A2 Assembly on a 15-pin extender board.
- b. Connect the instrument to a variable ac voltage source set for 115 Vac.

- c. Connect an HP 412A voltmeter to A2 pin 11 and check for a reading of +18 Vdc \pm .2 Vdc. If the +18 Vdc level is incorrect, adjust A2R5. Front-panel meter indication in the SUPPLY position should be about 3.6 Volts.
- d. Vary the ac line voltage from 103 to 127 Vac; dc output voltage should remain between +17.8 Vdc and +18.2 Vdc.
- e. Remove ac power, remove the extender board and reinstall the A2 Assembly.

5-22. Input Preamplicifier Gain Adjustment A5R2

5-23. Some instruments do not have an input preamplicifier assembly installed. Check the configuration label provided (see paragraph 3-2) to see if your unit contains this assembly. If the signal to be distributed is known or is available, use it or use a frequency of the same input level. If the level of the frequency to be distributed is unknown, use a 1 Vrms input from the test oscillator. To adjust the input amplifier gain, do the following:

- a. Connect a signal as described above to the appropriate input Jack (A, B, or C).
- b. Set front-panel CIRCUIT CHECK switch to input channel being used (A, B, or C).
- c. Adjust PREAMPLIFIER GAIN ADJUST A, B, or C for a CIRCUIT CHECK meter indication of .3 Volts \pm .1 Volts.
- d. Repeat steps a through c for the remaining preamplicifiers while using the appropriate input signal.

5-24. Output Amplifier Adjustments

5-25. Second-harmonic distortion is reduced by adjusting the tuned-circuits and balancing the current through the output transistors. Balance adjustment R13 is set for a minimum second-harmonic signal level by adjusting it for a null or minimum indication on the output signal. This adjustment is made only after a repair to the output amplifier, or if tests show excessive second harmonic distortion. Two methods of doing this adjustment are provided; here is the simple method:

- a. Obtain an R.F. Voltmeter such as that listed in Table 5-1 and use a signal source of the appropriate frequency. Remove instrument top cover and then the metal shield. Mount the output amplifier to be adjusted on a 15-pin extender board.
- b. Connect the signal source to the appropriate input channel BNC. Select the CIRCUIT CHECK switch position which corresponds to the input channel used. Adjust the source amplitude (or the input amplifier gain) for .3 Volt CIRCUIT CHECK meter indication.
- c. Connect the R.F. Voltmeter, terminated with 50-Ohms, to the appropriate output BNC. Adjust R1 for a reading of about 3 Vrms on the R.F. Voltmeter.
- d. Adjust T1 and T2 for a maximum reading on the R.F. Voltmeter. Readjust R1 for a 3 Vrms reading on the R.F. Voltmeter. Front-panel meter should read 3 Volts \pm .3 Volts.
- e. Carefully adjust R13 for a "null" minimum indication on the R.F. Voltmeter. The change in meter reading is about .15 Vrms. At the "null" the meter will read about 2.85 Vrms.
- f. Readjust the amplifier output gain (R1) for the desired output voltage.
- g. Repeat steps a through f for each output amplifier assembly. If paragraph 5-26 is not to be done, replace sheet metal cover.

5-26. A second method, using a spectrum analyzer, enables the second-harmonic distortion to be reduced to its lowest level. The procedure is:

- a. Do the steps in paragraph 5-25.

CAUTION

1-Volt Maximum on Spectrum Analyzer Input. Use 141T display on STORAGE STANDARD only. Start with INTENSITY and PERSISTENCE set to maximum ccw. Otherwise, damage to the display may result.

- b. Obtain a spectrum analyzer and read the preceding CAUTION before starting. Depending on the amplifier to be adjusted (10 MHz, 5 MHz, 1 MHz, or 100 kHz), set the analyzers controls using Table 5-2. Do not connect signal at this time.

Table 5-2. Spectrum Analyzer Control Settings

Spectrum Analyzer Control Settings	10 MHz AMP	5 MHz AMP	1 MHz AMP	100 kHz AMP
On the HP 8553B Set: RANGE FREQUENCY BANDWIDTH SCANWIDTH INPUT ATTEN.	0-110 MHz 10 MHz 100 kHz 10 MHz/DIV 20 dB	0-110 MHz 5 MHz 100 kHz 5 MHz/DIV 20 dB	0-11 MHz 1 MHz 10 kHz 1 MHz/DIV 20 dB	0-11 MHz 100 kHz 3 kHz 100 kHz/DIV 20 dB
On the HP 8552B Set: BASELINE CLIPPER SCAN TIME LOG. REF. LEVEL VIDEO FILTER SCAN MODE SCAN TRIGGER	ccw 5 msec 10 dB OFF INT AUTO	ccw 5 msec 10 dB OFF INT AUTO	ccw 20 msec 10 dB OFF INT AUTO	ccw 20 msec 10 dB OFF INT AUTO
On the HP 141T Set: STORAGE PERSISTENCE INTENSITY	STD 1/8 turn cw cw so trace is just visible	STD 1/8 turn cw cw so trace is just visible	STD 1/4 turn cw cw so trace is just visible	STD 1/8 turn cw cw so trace is just visible

- c. Connect a BNC Tee to the amplifier OUTPUT BNC. Connect an R.F. Voltmeter to one side of the Tee. Connect the other side of the Tee through a 20 dB attenuator to the spectrum analyzer R.F. INPUT. Adjust amplifier R1 for an R.F. meter reading, 3 Vrms.
- d. Adjust the LOG REF. LEVEL on the Analyzer so the displayed fundamental signal is at 0 dB.

- e. Adjust amplifier R13 to minimize the second-harmonic sideband. Ignore all responses to the left of the fundamental as they are image signals. Second-harmonic (and all other harmonics) should be down at least -40 dB below the fundamental signal.

NOTE

For lowest possible second-harmonic signal, remove amplifier under test from extender board and replace in socket. Observing spectrum analyzer, make a final adjustment to R13.

- f. Check for non-harmonically related signals by adjusting the spectrum analyzer controls listed below:

<u>Spectrum Analyzer Controls</u>	<u>10 MHz AMP</u>	<u>5 MHz AMP</u>	<u>1 MHz AMP</u>	<u>100 kHz AMP</u>
On the HP 8553B Set:				
SCANWIDTH	2 MHz/DIV	1 MHz/DIV	500 kHz/DIV	50 kHz/DIV
BANDWIDTH	1 kHz	1 kHz	1 kHz	1 kHz
On the HP 8552B Set:				
SCAN TIME	5 sec	2 sec	1 sec	5 sec
LOG REF LEVEL	0 dB	0 dB	0 dB	0 dB
VIDEO FILTER	10 kHz	10 kHz	10 kHz	10 kHz

- g. All non-harmonically related signals should be down at least -80 dB (-70 dB on the display). Ignore all responses to the left of the fundamental signal.
- h. Repeat steps c through g for each active output. When completed, adjust each output amplifier for the desired output level. Remove the extender board, disconnect the spectrum analyzer and reinstall the metal cover. This completes the output amplifier adjustment.

5-27. FREQUENCY DIVIDER LEVEL ADJUSTMENT A6, A7, A13, A14

5-28. Some instruments do not have Frequency Divider assemblies installed. Check the configuration label provided (see paragraph 3-2) to see if your unit contains any of these assemblies. This adjustment is normally performed only after repairs have been made to the divider circuit assembly. The adjustment procedures are for the following divider circuits:

- A6: 5 MHz-to-1 MHz
- A7: 1 MHz-to-100 kHz
- A13: 10 MHz-to-5 MHz
- A14: 10 MHz-to-1 MHz

To peak the output level, remove the instrument top cover, then the metal shield and mount the appropriate divider on a 15-pin extender board. Adjust T1 as follows:

- a. Connect the correct input frequency (10 MHz, 5 MHz, or 1 MHz) to the input (A, B, C) which drives the divider (see input configuration label and paragraph 3-2).
- b. With an R.F. Voltmeter or oscilloscope, monitor the divider output at pin P, R, or S.
- c. Adjust T1 for maximum indication on the R.F. Voltmeter or oscilloscope.
- d. The output signal should be about .2 to .6 Vrms depending on the number of output amplifiers being driven.
- e. Remove extender board and replace divider circuit assembly, the metal shield and top cover if no further adjustments are to be performed.

5-29. FREQUENCY DOUBLER ADJUSTMENTS, A11

5-30. Some instruments do not have Frequency Doubler Assemblies installed. Check the configuration label provided (see paragraph 3-2) to see if your unit contains any of these assemblies. These adjustments are performed only when repairs have been made to this assembly. To make any adjustments on this assembly, remove the instrument top cover and the metal shield. Then remove the printed circuit board shield from A11 Frequency Doubler Assembly and mount the Doubler Assembly on an extender board. Do the adjustments as follows:

- a. Connect a 5 MHz source to the appropriate input jack (INPUT A, B, or C). The 5 MHz signal level must be within a .3 Vrms to 3 Vrms range.
- b. Connect an R.F. Voltmeter or an oscilloscope to the appropriate output jack. The output selected must be a 10 MHz Amplifier (A12) whose input comes from the A11 Frequency Doubler output.
- c. Adjust level of 10 MHz output being monitored to 2 Vrms. Adjust A11C7, C13, and C17 for a maximum R.F. Voltmeter or oscilloscope indication. Repeat these adjustments until maximum indication is obtained. The front-panel meter position which corresponds to the A11 Frequency Doubler output should indicate .05 to .7 Volts depending on the number of amplifiers being driven by the frequency doubler (.3 to 1 Vrms from assembly).
- d. Adjust A12R1 for the desired output level.

5-31. IN-CABINET PERFORMANCE CHECKS

5-32. Use the procedures in Table 5-3 to make an in-cabinet performance check. A PERFORMANCE CHECK TEST CARD for recording test results follows Table 5-3.

Table 5-3. In-Cabinet Performance Checks

OPERATIONAL CHECKS	
1.	<p>ADJUSTMENTS</p> <p>Before doing the performance checks, the Input Preamplifiers (if used) must be adjusted. The signal used depends on the users' facility, but must be between .3 Vrms and 3 Vrms. Adjust the Input Preamplifiers and the Output Amplifiers using the method in Operational Checks, steps 3 and 4.</p>
2.	<p>CONFIGURATION</p> <p>Instrument configuration may vary depending on the options ordered. Check the configuration label included with the instrument (see paragraph 3-2), before doing the In-Cabinet Performance Checks. The label lists required input frequencies, available output frequencies, and the active input and output channels.</p>
3.	<p>INPUT ADJUSTMENTS (refer to paragraph 5-22 as a guide)</p> <ol style="list-style-type: none"> a. Determine, from the configuration label, whether Input Preamplifiers are used. Remove the instrument top cover and apply ac power. b. If Input Preamplifiers are used, connect a test signal from a signal source such as an HP 651B, to one of the input channels which contains a preamplifier. c. Set the HP 651B to the proper input frequency at .3 Vrms. Monitor the HP 651B output with an electronic counter. d. Set the front-panel CIRCUIT CHECK switch to the input channel being used. Adjust this INPUT amplifier for an instrument front-panel reading of .3 Volts \pm .1 Volts.
4.	<p>OUTPUT ADJUSTMENTS</p> <ol style="list-style-type: none"> a. From the configuration label, determine which output channels are active and what frequencies are used. b. Connect a signal source to the active input channel and set the source to the same frequency as the output amplifier. c. Adjust the Input Amplifier for .3 Volts on the front-panel meter (see 3 above). d. Connect an R.F. Voltmeter, terminated with 50-Ohms, to the active output channel being adjusted. e. Adjust the output amplifier being monitored for an R.F. Voltmeter reading of 3 Vrms. f. Front-panel meter should indicate 3 Volts \pm .3 Volts in CIRCUIT CHECK switch positions which correspond to the active channels.
5.	<p>In addition to checking the active input and output channels front-panel meter readings, check SUPPLY position of the CIRCUIT CHECK switch. Indication should be 3.6 Volts \pm .2 Volts.</p>

Table 5-3. In-Cabinet Performance Checks (Continued)

PERFORMANCE CHECKS																								
<p>1. HARMONIC DISTORTION</p> <p>Harmonic distortion for 10 MHz, 5 MHz, 1 MHz, and 100 kHz should be more than 40 dB below the output level. A spectrum analyzer is tuned to the fundamental frequency, a reference level is established and the sidebands are checked for second-harmonic signals. To check for harmonic distortion, do the following:</p> <p>a. Obtain a spectrum analyzer and depending on the frequency, set the spectrum analyzer controls as follows (read the CAUTION):</p> <p style="text-align: center;">CAUTION</p> <p style="text-align: center;">1-Volt maximum on input. Use the HP 141T display on STORAGE STANDARD only. Start with INTENSITY and PERSISTENCE set to maximum ccw. Damage to the display may result.</p> <p style="text-align: center;">Table 5-3a. Spectrum Analyzer Control Settings</p> <table border="1"> <thead> <tr> <th>Spectrum Analyzer Control Settings</th> <th>10 MHz AMPS</th> <th>5 MHz AMPS</th> <th>1 MHz AMPS</th> <th>100 kHz AMPS</th> </tr> </thead> <tbody> <tr> <td> On the HP 8553B Set: RANGE FREQUENCY BANDWIDTH SCANWIDTH INPUT ATTENUATOR </td> <td> 0-110 MHz 10 MHz 100 kHz 10 MHz/Div 20 dB </td> <td> 0-110 MHz 5 MHz 100 kHz 5 MHz/DIV 20 dB </td> <td> 0-11 MHz 1 MHz 100 kHz 1 MHz/DIV 20 dB </td> <td> 0-11 MHz 100 kHz 3 kHz 100 kHz/DIV 20 dB </td> </tr> <tr> <td> On the HP 8552B Set: BASELINE CLIPPER SCAN TIME LOG. REF LEVEL SCAN MODE SCAN TRIGGER </td> <td> ccw 5 msec 10 dB INT AUTO </td> <td> ccw 5 msec 10 dB INT AUTO </td> <td> ccw 20 msec 10 dB INT AUTO </td> <td> ccw 20 msec 10 dB INT AUTO </td> </tr> <tr> <td> On the HP 141T Set: STORAGE PERSISTENCE INTENSITY </td> <td> STD 1/8 turn cw cw so trace is just visible </td> <td> STD 1/8 turn cw cw so trace is just visible </td> <td> STD 1/4 turn cw cw so trace is just visible </td> <td> STD 1/8 turn cw cw so trace is just visible </td> </tr> </tbody> </table>					Spectrum Analyzer Control Settings	10 MHz AMPS	5 MHz AMPS	1 MHz AMPS	100 kHz AMPS	On the HP 8553B Set: RANGE FREQUENCY BANDWIDTH SCANWIDTH INPUT ATTENUATOR	0-110 MHz 10 MHz 100 kHz 10 MHz/Div 20 dB	0-110 MHz 5 MHz 100 kHz 5 MHz/DIV 20 dB	0-11 MHz 1 MHz 100 kHz 1 MHz/DIV 20 dB	0-11 MHz 100 kHz 3 kHz 100 kHz/DIV 20 dB	On the HP 8552B Set: BASELINE CLIPPER SCAN TIME LOG. REF LEVEL SCAN MODE SCAN TRIGGER	ccw 5 msec 10 dB INT AUTO	ccw 5 msec 10 dB INT AUTO	ccw 20 msec 10 dB INT AUTO	ccw 20 msec 10 dB INT AUTO	On the HP 141T Set: STORAGE PERSISTENCE INTENSITY	STD 1/8 turn cw cw so trace is just visible	STD 1/8 turn cw cw so trace is just visible	STD 1/4 turn cw cw so trace is just visible	STD 1/8 turn cw cw so trace is just visible
Spectrum Analyzer Control Settings	10 MHz AMPS	5 MHz AMPS	1 MHz AMPS	100 kHz AMPS																				
On the HP 8553B Set: RANGE FREQUENCY BANDWIDTH SCANWIDTH INPUT ATTENUATOR	0-110 MHz 10 MHz 100 kHz 10 MHz/Div 20 dB	0-110 MHz 5 MHz 100 kHz 5 MHz/DIV 20 dB	0-11 MHz 1 MHz 100 kHz 1 MHz/DIV 20 dB	0-11 MHz 100 kHz 3 kHz 100 kHz/DIV 20 dB																				
On the HP 8552B Set: BASELINE CLIPPER SCAN TIME LOG. REF LEVEL SCAN MODE SCAN TRIGGER	ccw 5 msec 10 dB INT AUTO	ccw 5 msec 10 dB INT AUTO	ccw 20 msec 10 dB INT AUTO	ccw 20 msec 10 dB INT AUTO																				
On the HP 141T Set: STORAGE PERSISTENCE INTENSITY	STD 1/8 turn cw cw so trace is just visible	STD 1/8 turn cw cw so trace is just visible	STD 1/4 turn cw cw so trace is just visible	STD 1/8 turn cw cw so trace is just visible																				
<p>b. Connect a BNC Tee to the amplifier OUTPUT jack. Connect an R.F. Voltmeter to one side of the Tee. Connect the other side of the Tee through a 20 dB attenuator to the Spectrum Analyzer R.F INPUT.</p> <p>c. Adjust the LOG REF. LEVEL so that the displayed fundamental signal is at 0 dB.</p> <p>d. Ignore all responses to the left of the fundamental, as they are image signals. Second-harmonics and all other harmonics should be down at least 40 dB below the fundamental signal.</p>																								

Table 5-3. In-Cabinet Performance Checks (Continued)

PERFORMANCE CHECKS (CONTINUED)				
<p>2. NON-HARMONICALLY RELATED SIGNALS</p> <p>Non-harmonically related signals must be more than 80 dB below the output level. The spectrum analyzer remains connected, and the amplifier output levels remain the same as in the preceding test for harmonic distortion. The spectrum analyzer controls are reset as described in Table 5-3b. NOTE: Be sure the 20 dB attenuator connected to the spectrum analyzer input remains in place.</p> <ol style="list-style-type: none"> Connect each amplifier output to the spectrum analyzer. Adjust spectrum analyzer as described in Table 5-3b. All non-harmonically related signals displayed to the right of the output signal must be below the 60 dB line on the spectrum analyzer. NOTE: In this test the LOG REF. LEVEL is set to 0 dB, or 20 dB more sensitive than in the preceding test. Thus, the 60 dB line on the spectrum analyzer screen is actually 80 dB below the output signal level. 				
<p>Table 5-3b. Changes in Controls Settings to Check for Non-Harmonically Related Signals</p>				
Spectrum Analyzer Control Setting	10 MHz AMPS	5 MHz AMPS	1 MHz AMPS	100 kHz AMPS
On the HP 8553B Set: SCANWIDTH BANDWIDTH	2 MHz/DIV 1 kHz	1 MHz/DIV 1 kHz	500 kHz/DIV 1 kHz	50 kHz/DIV 1 kHz
On the HP 8552B Set: SCAN TIME LOG REF LEVEL VIDEO FILTER	5 sec 0 dB 10 kHz	2 sec 0 dB 10 kHz	1 sec 0 dB 10 kHz	5 sec 0 dB 10 kHz
<p>3. CROSSTALK</p> <p>Specifications pertaining to crosstalk apply only when the 5087A has two or three different input frequencies. In this test for crosstalk all input signals except one are removed. The output from the channel or channels with no input is then examined for presence of the remaining input signal. If the instrument is configured to use only one input signal such as options 032 or 033, this test does not apply.</p> <ol style="list-style-type: none"> If the instrument is configured to operate with more than one input signal frequency, connect only one input signal to the appropriate rear-panel input jack. Set level in the active input channel to 0.3 volts as indicated on front-panel meter. If either of the other input channels is a multiplier or divider (such as options 005, 006, 011, 013 or 014) remove ac power. Remove top cover and shield and temporarily remove any such multiplier or divider input boards. This will provide only one output frequency. Replace shield and apply ac power. Set level on all active output channels to 3 Volts as indicated on front-panel meter. Check for crosstalk signals at the rear panel BNC's of one or more of the inactive channels. Any signals present (coming from the active channels) must be less than 3 mV (60 dB below output levels). An R.F. Voltmeter or a spectrum analyzer may be used for this test. If an R.F. Voltmeter is used, be sure any signals measured are coming from the 5087A and not from other sources such as nearby equipment. 				

Table 5-3. In-Cabinet Performance Check (Continued)

PERFORMANCE CHECKS (CONTINUED)	
4. INJECTED SIGNAL	
<p>In this test, a signal is injected into one of the <i>output</i> terminals of the 5087A. If this signal is present at other output terminals, it should be down 60 dB below the level of the injected signal. The 10 MHz output channel will be down more than 50 dB (for a test signal frequency other than 10 MHz).</p>	
a.	With the 5087A set for normal operation and AC power applied, remove all signal inputs from rear panel connectors A, B, and C.
b.	Connect a 1 Vrms signal to any output connector (1 through 12).
c.	Check the other outputs for presence of this signal. Its level must be $\leq 300 \mu\text{Vrms}$. A wave analyzer or sensitive R.F. Voltmeter may be used for this test. If a voltmeter is used, verify that any signal observed originates from the 5087A. This is done by disconnecting the test signal applied in step b and noting that the voltmeter reading drops.
d.	Repeat step c as desired using other output channels for the input signal. Frequencies of 10 MHz, 5 MHz, 1 MHz, and 100 kHz may also be used.
e.	Reassemble the 5087A. Reinstall all circuit boards, shield, and top or bottom covers. This completes the test.

PERFORMANCE CHECK TEST CARD

HEWLETT-PACKARD MODEL 5087A
DISTRIBUTION AMPLIFIER

Tests performed by _____

Serial No. _____-_____

Date _____

OPERATIONAL CHECKS

Description	Check
1. ADJUSTMENTS	<input type="checkbox"/>
2. CONFIGURATIONS	<input type="checkbox"/>
3. INPUT ADJUSTMENT	<input type="checkbox"/>
4. OUTPUT ADJUSTMENTS	<input type="checkbox"/>
5. METER READINGS	<input type="checkbox"/>

PERFORMANCE CHECKS

Description	Check
1. HARMONIC DISTORTION: -40 dB or more from rated output.	_____ dB
2. NON-HARMONICALLY RELATED SIGNALS: -80 dB or more from rated output.	_____ dB
3. CROSSTALK: -60 dB or more measured channel-to-channel; not applicable with one input frequency.	_____ dB
4. INJECTED SIGNAL: No signal input; 1V signal up to 50 MHz applied to any output (except 10 MHz) will be down at least 60 dB in all other outputs. Injection in the 10 MHz output will be down at least 50 dB.	_____ dB

PERFORMANCE CHECK TEST CARD

*HEWLETT-PACKARD MODEL 5087A
DISTRIBUTION AMPLIFIER*

Tests performed by _____

Serial No. _____

Date _____

OPERATIONAL CHECKS

Description	Check
1. ADJUSTMENTS	□
2. CONFIGURATIONS	□
3. INPUT ADJUSTMENT	□
4. OUTPUT ADJUSTMENTS	□
5. METER READINGS	□

PERFORMANCE CHECKS

Description	Check
1. HARMONIC DISTORTION: -40 dB or more from rated output.	_____ dB
2. NON-HARMONICALLY RELATED SIGNALS: -80 dB or more from rated output.	_____ dB
3. CROSSTALK: -60 dB or more measured channel-to-channel; not applicable with one input frequency.	_____ dB
4. INJECTED SIGNAL: No signal input; 1V signal up to 50 MHz applied to any output (except 10 MHz) will be down at least 60 dB in all other outputs. Injection in the 10 MHz output will be down at least 50 dB.	_____ dB

SECTION VI REPLACEABLE PARTS

6-1. INTRODUCTION

6-2. This section contains parts number information needed to order replacement parts. Table 6-2 lists parts by assembly reference designation. The part numbers also provide the following information on each part:

- a. Description of part (see abbreviations in Table 6-1).
- b. Typical manufacturer of the part in a five-digit code; see list of manufacturers in Table 6-3.
- c. Manufacturer's part number.
- d. Quantity used in each assembly (Qty column).

6-3. ORDERING INFORMATION

6-4. To obtain replacement parts, address inquiry to the nearest Hewlett-Packard Sales and Service Office (see lists at rear of this manual for addresses). Identify parts by their Hewlett-Packard part numbers.

6-5. To obtain a part not listed, include:

- a. Instrument model number.
- b. Instrument serial number.
- c. Description of the part.
- d. Function and location of the part.

Table 6-1. Table of Abbreviations

REFERENCE DESIGNATIONS							
A	= assembly	E	= miscellaneous electrical part	P	= electrical connector (movable portion); plug	U	= integrated circuit; microcircuit
AT	= attenuator; isolator; termination	F	= fuse	Q	= transistor; SCR; triode thyristor	V	= electron tube
B	= fan; motor	FL	= filter	R	= resistor	VR	= voltage regulator; breakdown diode
BT	= battery	H	= hardware	RT	= thermistor	W	= cable; transmission path; wire
C	= capacitor	HY	= circulator	S	= switch	X	= socket
CP	= coupler	J	= electrical connector (stationary portion); jack	T	= transformer	Y	= crystal unit—piezo-electric
CR	= diode; diode thyristor; varactor	K	= relay	TB	= terminal board	Z	= tuned cavity; tuned circuit
DC	= directional coupler	L	= coil; inductor	TC	= thermocouple		
DL	= delay line	M	= meter	TP	= test point		
DS	= annunciator; signaling device (audible or visual); lamp; LED	MP	= miscellaneous mechanical part				

ABBREVIATIONS							
A	= ampere	avg	= average	CHAN	= channel	dc	= direct current
ac	= alternating current	AWG	= American wire gauge	cm	= centimeter	deg	= degree (temperature interval or difference)
ACCESS	= accessory	BAL	= balance	CMO	= cabinet mount only	...°	= degree (plane angle)
ADJ	= adjustment	BCD	= binary coded decimal	COAX	= coaxial	°C	= degree Celsius (centigrade)
A/D	= analog-to-digital	BD	= board	COEF	= coefficient	°F	= degree Fahrenheit
AF	= audio frequency	BE CU	= beryllium copper	COM	= common	°K	= degree Kelvin
AFC	= automatic frequency control	BFO	= beat frequency oscillator	COMP	= composition	DEPC	= deposited carbon
AGC	= automatic gain control	BH	= binder head	COMPL	= complete	DET	= detector
AL	= aluminum	BKDN	= breakdown	CONN	= connector	diam	= diameter
A/C	= automatic level control	BP	= bandpass	CP	= cadmium plate	DIA	= diameter (used in parts list)
AM	= amplitude modulation	BPF	= bandpass filter	CRT	= cathode-ray tube		
AMPL	= amplifier	BRS	= brass	CTL	= complementary transistor logic		
APC	= automatic phase control	BWO	= backward-wave oscillator	CW	= continuous wave	DIFF	= differential amplifier
ASSY	= assembly	CAL	= calibrate	cw	= clockwise	AMPL	= division
AUX	= auxiliary	ccw	= counterclockwise	cm	= centimeter	div	= division
		CER	= ceramic	D/A	= digital-to-analog	DPIOT	= double-pole, double-throw
				dB	= decibel	DR	= drive
				dBm	= decibel referred to 1 mW		

Table 6-1. Table of Abbreviations (Continued)

ABBREVIATIONS			
DSB = double sideband	MFR = manufacturer	PIV = peak inverse voltage	TFT = thin-film transistor
DTL = diode transistor logic	mg = milligram	pk = peak	TGL = toggle
DVM = digital voltmeter	MHz = megahertz	PLI = phase lock	THD = thread
ECL = emitter coupled logic	mH = millihenry	PLO = phase lock oscillator	THRU = through
EMF = electromotive force	mho = mho	PM = phase modulation	TI = titanium
EDP = electronic data processing	MIN = minimum	PNP = positive-negative-positive	TOI = tolerance
ELECT = electrolytic	min = minute (time)	P/O = part of	TRIM = trimmer
ENCAP = encapsulated	... = minute (plane angle)	POLY = polystyrene	TSTR = transistor
EXT = external	MINAT = miniature	PORC = porcelain	TTL = transistor-transistor logic
F = farad	mm = millimeter	POS = positive; position(s) (used in parts list)	TV = television
FET = field-effect transistor	MOD = modulator	POSN = position	TVI = television interference
F/F = flip-flop	MOM = momentary	POT = potentiometer	TWT = traveling wave tube
FH = flat head	MOS = metal-oxide semiconductor	p-p = peak-to-peak	U = micro (10 ⁻⁶) (used in parts list)
FIL.H = fillister head	ms = millisecond	PP = peak-to-peak (used in parts list)	UF = microfarad (used in parts list)
FM = frequency modulation	MTG = meter (indicating device)	PPM = pulse-position modulation	UHF = ultrahigh frequency
FP = front panel	mV = millivolt	PREAMPL. = preamplifier	UNREG = unregulated
FREQ = frequency	mVac = millivolt, ac	PRF = pulse-repetition frequency	V = volt
FXD = fixed	mVdc = millivolt, dc	PRR = pulse repetition rate	VA = voltampere
g = gram	mVpk = millivolt, peak	ps = picosecond	Vac = volts, ac
GE = germanium	mV p-p = millivolt, peak-to-peak	PT = point	VAR = variable
GHz = gigahertz	mVrms = millivolt, rms	PTM = pulse-time modulation	VCO = voltage-controlled oscillator
GL = glass	mW = milliwatt	PWM = pulse-width modulation	Vdc = volts, dc
GND = ground(ed)	MUX = multiplex	PWV = peak working voltage	VDCW = volts, dc, working (used in parts list)
H = henry	MY = mylar	RC = resistance capacitance	V(F) = volts, filtered
h = hour	μA = microampere	RECT = rectifier	VFO = variable-frequency oscillator
HET = heterodyne	μF = microfarad	REF = reference	VHF = very-high frequency
HEX = hexagonal	μH = microhenry	REG = regulated	Vpk = volts, peak
HD = head	μmho = micromho	REPL. = replaceable	Vp-p = volts, peak-to-peak
HDW = hardware	μs = microsecond	RF = radio frequency	Vrms = volts, rms
HF = high frequency	μV = microvolt	RFI = radio frequency interference	VSWR = voltage standing wave ratio
HG = mercury	μVac = microvolt, ac	RH = round head; right hand	VTO = voltage-tuned oscillator
HI = high	μVdc = microvolt, dc	RIC = resistance-inductance-capacitance	VTVM = vacuum-tube voltmeter
HP = Hewlett-Packard	μVpk = microvolt, peak	RMO = rack mount only	V(X) = volts, switched
HPF = high pass filter	μVp-p = microvolt, peak-to-peak	rms = root-mean-square	W = watt
HR = hour (used in parts list)	μVrms = microvolt, rms	RND = round	W/ = with
HV = high voltage	nA = nanoampere	ROM = read-only memory	WIV = working inverse voltage
Hz = Hertz	NC = no connection	R&P = rack and panel	WW = wirewound
IC = integrated circuit	N/C = normally closed	RWV = reverse working voltage	W/O = without
ID = inside diameter	NE = neon	S = scattering parameter	YIG = yttrium-iron-garnet
IF = intermediate frequency	NEG = negative	s = second (time)	Zo = characteristic impedance
IMPG = impregnated	nF = nanofarad	...'' = second (plane angle)	
in = inch	NI PL. = nickel plate	S-B = slow-blow (fuse) (used in parts list)	
INCD = incandescent	N/O = normally open	SCR = silicon controlled rectifier; screw	
INCL. = include(s)	NOM = nominal	SE = selenium	
INP = input	NORM = normal	SECT = sections	
INS = insulation	NPN = negative-positive-negative	SEMICON = semiconductor	
INT = internal	NPO = negative-positive zero (zero temperature coefficient)	SHF = superhigh frequency	
kg = kilogram	NRFR = not recommended for field replacement	SI = silicon	
kHz = kilohertz	NSR = not separately replaceable	SIL = silver	
kΩ = kilohm	ns = nanosecond	SL = slide	
kV = kilovolt	nW = nanowatt	SNR = signal-to-noise ratio	
lb = pound	OBD = order by description	SPDT = single-pole, double-throw	
LC = inductance-capacitance	OD = outside diameter	SPG = spring	
LED = light-emitting diode	OH = oval head	SR = split ring	
LF = low frequency	OP AMPL. = operational amplifier	SPST = single-pole, single-throw	
LG = long	OPT = option	SSB = single sideband	
LH = left hand	OSC = oscillator	SST = stainless steel	
LIM = limit	OX = oxide	STL = steel	
LIN = linear taper (used in parts list)	oz = ounce	SQ = square	
lin = linear	Ω = ohm	SWR = standing-wave ratio	
LK = lock washer	P = peak (used in parts list)	SYNC = synchronize	
LO = low; local oscillator	PAM = pulse-amplitude modulation	T = timed (slow-blow fuse)	
LOG = logarithmic taper (used in parts list)	PC = printed circuit	TA = tantalum	
log = logarithmic	PCM = pulse-code modulation; pulse-count modulation	TC = temperature compensating	
LPF = low pass filter	PDM = pulse-duration modulation	TD = time delay	
L.V. = low voltage	pF = picofarad	TERM = terminal	
m = meter (distance)	PH BRZ = phosphor bronze		
mA = milliampere	PHI. = Phillips		
MAX = maximum	PIN = positive-intrinsic-negative		
MΩ = megohm			
MEG = meg (10 ⁶) (used in parts list)			
MET.FLM = metal film			
MET.OX = metal oxide			
MF = medium frequency; microfarad (used in parts list)			

NOTE
All abbreviations in the parts list will be in upper case.

MULTIPLIERS

Abbreviation	Prefix	Multiple
T	tera	10 ¹²
G	giga	10 ⁹
M	mega	10 ⁶
k	kilo	10 ³
da	deka	10
d	deci	10 ⁻¹
c	centi	10 ⁻²
m	milli	10 ⁻³
μ	micro	10 ⁻⁶
n	nano	10 ⁻⁹
p	pico	10 ⁻¹²
f	femto	10 ⁻¹⁵
a	atto	10 ⁻¹⁸

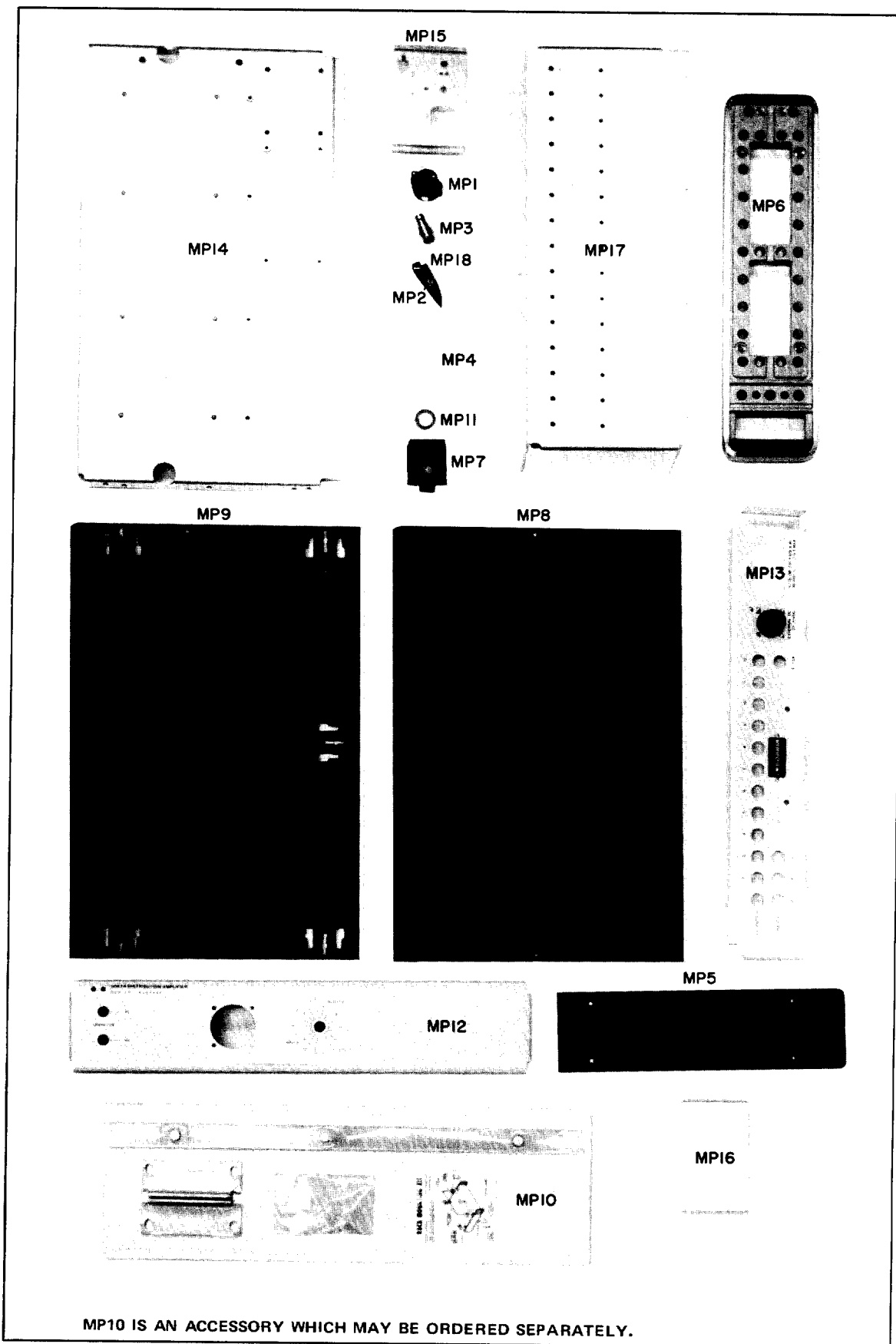

Figure 6-1. Mechanical Parts

Model 5087A
Replaceable Parts

Table 6-2. Replaceable Parts

Reference Designation	HP Part Number	Qty	Description	Mfr Code	Mfr Part Number
A1	5060-1189	1	POWER LINE MODULE, NON-FILTERED	28480	5060-1189
A2	05087-60008	1	BOARD ASSY: POWER SUPPLY	28490	05087-60008
A3	05087-60015	1	BOARD ASSY: MOTHER (SERIES 1620)	28480	05087-60015
A4	05087-60009	1	BOARD ASSY: CIRC CHECK	28480	05087-60009
A5	05087-60004	1+	BOARD ASSY: INPUT PREAMPLIFIER (USED WITH OPTN 004)	28490	05087-60004
A6	05087-60005	1+	BOARD ASSY: DIV. 5/1MHZ (USED WITH OPTN 005)	28480	05087-60005
A7	05087-60006	1+	BOARD ASSY: DIV. 1MHZ (USED WITH OPTN 006)	28480	05087-60006
A8	05087-60001	1+	BOARD ASSY: AMP, 5MHZ (USED WITH OPTN 001)	28480	05087-60001
A9	05087-60002	1+	BOARD ASSY: AMP, 1MHZ (USED WITH OPTN 002)	28480	05087-60002
A10	05087-60003	1+	BOARD ASSY: AMP 100KHZ (USED WITH OPTN 003)	28480	05087-60003
A11	05087-60011	1+	BOARD ASSY: DOUBLER 5 MHz to 100 MHz (USED WITH OPTN 011)	28480	05087-60011
A12	05087-60012	1+	BOARD ASSY: AMP 10 MHz (USED WITH OPTN 012)	28480	05087-60012
A13	05087-60013	1+	BOARD ASSY: DIVIDER 10 MHz to 5 MHz (USED WITH OPTN 013)	28480	05087-60013
A14	05087-60014	1+	BOARD ASSY: DIVIDER 10 MHz to 1 MHz (USED WITH OPTN 014)	28480	05087-60014
C1	0180-2188	1	C:FXD AL ELECT 1500 UF +100-128 43VDCW	56289	62D10613-0FP
CS1	1450-0041	2	LAMPHOLDER ASSY: WHITE LENS	72765	5154-036-804 _1
CS1	2140-0025	2	LAMP: INCANDESCENT 28.0V 0.04 AMPS	08806	327
CS2	1450-0041	2	LAMPHOLDER ASSY: WHITE LENS	72765	5154-036-804 _1
CS2	2140-0025	2	LAMP: INCANDESCENT 28.0V 0.04 AMPS	08806	327
F1	2110-0043	1	FUSE: CARTRIDGE 1.5 AMP 250V	75915	31201.5
J2	1251-0111	1	CONNECTOR: RECEPTACLE MALE 5-CONTACT	71468	MS3102R14S-5P
M1	1120-1565	1	METER	28480	1120-1565
MP1	0370-0112	1	KNOB: SKIRTED BAR BLK 0.750" DIA	28480	0370-0112
MP2	1200-0092	1	BUSHING: TRANSISTOR	02735	495334 1
MP3	1250-0870	15	BODY: RF CONNECTOR REAR MTG (J1 to J15)	27251	28JS112-1
MP4	5000-0050	2	TRIM: SIDES	28480	5000-0050
MP5	5000-8589	2	COVER: SIDE	28480	5000-8589
MP6	5060-0729	2	FRAME ASSY: 3 X 11(SIDE)	28480	5060-0729
MP7	5060-0767	5	FOOT ASSY: FM	28480	5060-0767
MP8	5060-8587	1	COVER ASSY: TOP (STD) OLIVE GRAY	28480	5060-8587
MP9	5060-8711	1	BOTTOM COVER	28480	5060-8711
MP10	5060-8739	1	KIT: RACK MOUNT (OPTIONAL)	28480	5060-8739
MP11	00310-48801	1	WASHER: SHOULDERED	28480	00310-48801
MP12	05087-00001	1	PANEL: FRONT	28480	05087-00001
MP13	05087-00002	1	PANEL: REAR	28480	05087-00002
MP14	05087-00003	1	CHASSIS: MAIN	28480	05087-00003
MP15	05087-00004	1	CHASSIS: POWER SUPPLY	28480	05087-00004
MP16	05087-00005	15	SHIELD: BOARD	28480	05087-00005
MP17	05087-00006	1	SHIELD: MAIN	28480	05087-00006
MP18	0403-0304	2	GUIDE: PC BOARD	28480	0403-0304
Q1	1854-0072	1	TSTR: SI NPN	80131	2N3054
Q1	0340-0162	1	INSULATOR: TSTR FOR TO-66	13103	A0340-0162-1
T1	9100-3023	1	TRANSFORMER, POWER	28480	9100-3023
W1	8120-1506	1	CABLE RIBBON: (5" LG)	91506	14010-2PB
W1	1251-2544	2	CONNECTOR: RIBBON CABLE, 26 CONTACT	91506	4P26-1
W2	8120-1378	1	CABLE ASSY: AC POWER CABD	70903	KH-7081
W3	05087-60026	3	CABLE ASSY: RF USED WITH J1 (INPUT A)	28480	05087-60026
W4	05087-60026	3	CABLE ASSY: RF J2 (INPUT B)	28480	05087-60026
W5	05087-60026	3	CABLE ASSY: RF J3 (INPUT C)	28480	05087-60026
W6	05087-60027	6	CABLE ASSY: RF USED WITH J4 (OUTPUT 1)	28480	05087-60027
W7	05087-60027	6	CABLE ASSY: RF THROUGH	28480	05087-60027
W8	05087-60027	6	CABLE ASSY: RF J9 (OUTPUT 6)	28480	05087-60027
W9	05087-60027	6	CABLE ASSY: RF	28480	05087-60027
W10	05087-60027	6	CABLE ASSY: RF	28480	05087-60027
W11	05087-60027	6	CABLE ASSY: RF	28480	05087-60027
W12	05087-60028	3	CABLE ASSY: RF USED WITH J10 (OUTPUT 7)	28480	05087-60028
W13	05087-60028	3	CABLE ASSY: RF THROUGH	28480	05087-60028
W14	05087-60028	3	CABLE ASSY: RF J12 (OUTPUT 9)	28480	05087-60028
W15	05087-60029	3	CABLE ASSY: RF USED WITH J13 (OUTPUT 10)	28480	05087-60029
W16	05087-60029	3	CABLE ASSY: RF THROUGH	28480	05087-60029
W17	05087-60029	3	CABLE ASSY: RF J15 (OUTPUT 12)	28480	05087-60029
XA2	1251-0160	1	CONNECTOR: PC EDGE 1 ROW 15 CONTACT	71785	230-15-30-21.0
XF1	1400-0085	1	FUSEHOLDER	75915	342004
MISC	05087-60031	1	KIT: ACCESSORY	28480	05087-60031

See introduction to this section for ordering information

Table 6-2. Replaceable Parts (Continued)

Reference Designation	HP Part Number	Qty	Description	Mfr Code	Mfr Part Number
A1	5060-1189	1	POWER LINE MODULE, NON-FILTERED	28480	5060-1189
A1F1	2110-0012	1	FUSE: .5 AMP 250V (FOR 115V OPERATION)	75915	
A1F1	2110-0004	1	FUSE: .25 AMP 250V (FOR 230V OPERATION)	75915	
A2	05087-60008	1	BOARD ASSY:POWER SUPPLY	28480	05087-60008
A2C1	0150-0096	1	C:FXD CER 0.05 UF +80-20% 100VDCW	91418	TA
A2C2	0140-0234	1	C:FXD MICA 500 PF 1%	28480	0140-0234
A2C3	0180-0116	2	C:FXD ELECT 6.8 UF 10% 35VDCW	56289	1500685X903582-DYS
A2C4	0180-0116	2	C:FXD ELECT 6.8 UF 10% 35VDCW	56289	1500685X903582-DYS
A2CR1	1901-0028	6	DIODE:SILICON 0.75A 400PIV	04713	SR1358-9
A2CR2	1901-0028		DIODE:SILICON 0.75A 400PIV	04713	SR1358-9
A2CR3	1901-0028		DIODE:SILICON 0.75A 400PIV	04713	SR1358-9
A2CR4	1901-0028		DIODE:SILICON 0.75A 400PIV	04713	SR1358-9
A2CR5	1901-0028		DIODE:SILICON 0.75A 400PIV	04713	SR1358-9
A2CR6	1901-0028		DIODE:SILICON 0.75A 400PIV	04713	SR1358-9
A2CR7	1902-0558	1	DIODE BREAKDOWN:12V 5% 1W	28480	1902-0558
A2L1	9100-1666	1	COIL/CHOKER:FXD 3600 UH 5%	28480	9100-1666
A2R1	0757-0912	2	R:FXD MET FLM 330 OHM 2% 1/8W	28480	0757-0912
A2R2	0757-0912	2	R:FXD MET FLM 330 OHM 2% 1/8W	28480	0757-0912
A2R3	0811-1553	1	R:FXD WW 2.68 OHM 5% 2W	28480	0811-1553
A2R4	0757-0939	1	R:FXD FLM 4.3K OHM 2% 1/8W	28480	0757-0939
A2R5	2100-2633	1	R:VAR CERMET 1K OHM 10% LIN 1/2W	28480	2100-2633
A2R6	0757-0934	1	R:FXD FLM 2.7K OHM 2% 1/8W	28480	0757-0934
A2R7	0761-0026	1	R:FXD MET OX 220 OHM 5% 1W	28480	0761-0026
A2U1	1820-0196	1	IC:LINEAR VOLTAGE REGULATOR	28480	MA 723
A3	05087-60015	1	BOARD ASSY: MOTHER (SERIES 1620)	28480	05087-60015
A3C1	0180-0116	1	C:FXD ELECT 6.8 UF 10% 35VDCW	56289	1500685X903582-DYS
A3L1	9140-0105	1	COIL/MOLDED CHOKER 8.20 UH 10%	28480	9140-0105
A3MPI	1251-2361	26	CONNECTOR:PC WRAP-POST TYPE FOR MTG.	00779	86091-2
A3XA1	1251-2035	15	CONNECTOR:PC EDGE (2 X 15) 30 CONTACT	71785	252-15-30-300
A3XA2	1251-2035		CONNECTOR:PC EDGE (2 X 15) 30 CONTACT	71785	252-15-30-300
A3XA3	1251-2035		CONNECTOR:PC EDGE (2 X 15) 30 CONTACT	71785	252-15-30-300
A3XA4	1251-2035		CONNECTOR:PC EDGE (2 X 15) 30 CONTACT	71785	252-15-30-300
A3XA5	1251-2035		CONNECTOR:PC EDGE (2 X 15) 30 CONTACT	71785	252-15-30-300
A3XA6	1251-2035		CONNECTOR:PC EDGE (2 X 15) 30 CONTACT	71785	252-15-30-300
A3XA7	1251-2035		CONNECTOR:PC EDGE (2 X 15) 30 CONTACT	71785	252-15-30-300
A3XA8	1251-2035		CONNECTOR:PC EDGE (2 X 15) 30 CONTACT	71785	252-15-30-300
A3XA9	1251-2035		CONNECTOR:PC EDGE (2 X 15) 30 CONTACT	71785	252-15-30-300
A3XA10	1251-2035		CONNECTOR:PC EDGE (2 X 15) 30 CONTACT	71785	252-15-30-300
A3XA11	1251-2035		CONNECTOR:PC EDGE (2 X 15) 30 CONTACT	71785	252-15-30-300
A3XA12	1251-2035		CONNECTOR:PC EDGE (2 X 15) 30 CONTACT	71785	252-15-30-300
A3XA(A)	1251-2035		CONNECTOR:PC EDGE (2 X 15) 30 CONTACT	71785	252-15-30-300
A3XA(B)	1251-2035		CONNECTOR:PC EDGE (2 X 15) 30 CONTACT	71785	252-15-30-300
A3XA(C)	1251-2035		CONNECTOR:PC EDGE (2 X 15) 30 CONTACT	71785	252-15-30-300
A4	05087-60009	1	BOARD ASSY:CIRC CHECK	28480	05087-60009
A4MPI	1251-2361	26	CONNECTOR:PC WRAP-POST TYPE FOR MTG.	00779	86091-2
A4K1	0757-0472	1	R:FXD MET FLM 200K OHM 1% 1/8W	28480	0757-0472
A4R2	0757-0963	1	R:FXD FLM 47K OHM 2% 1/8W	28480	0757-0964
A4S1	3100-2931	1	SWITCH:ROTARY 16-POSITION	28480	3100-2931
A5	05087-60004		BOARD ASSY:INPUT PREAMPLIFIER (USED WITH OPT 004)	28480	05087-60004
A5C1	0150-0121	1	C:FXD CER 0.1 UF +80-20% 50VDCW	56289	5C5081S-CML
A5C2	0180-1746	1	C:FXD ELECT 15 UF 10% 35VDCW	28480	0180-1746
A5C3	0180-0117	2	C:FXD ELECT 2.7 UF 10% 35VDCW	28480	0180-0117
A5C4	0180-0117	2	C:FXD ELECT 2.7 UF 10% 35VDCW	28480	0180-0117
A5CR1	1910-0016	1	DIODE:GE 60 MA 60VW	28480	1910-0016
A5L1	9140-0137	1	COIL:FXD RF 1000 UH 5%	28480	9140-0137
A5Q1	1854-0053	1	TSTR:SI NPN	80131	2N2218
A5R1	0757-0893	2	R:FXD FLM 51 OHM 2% 1/8W	28480	0757-0893
A5R2	2100-2633	1	R:VAR CERMET 1K OHM 10% LIN 1/2W	28480	2100-2633
A5R3	0757-0893		R:FXD FLM 51 OHM 2% 1/8W	28480	0757-0893
A5R4	0757-0932	2	R:FXD FLM 2.2K OHM 2% 1/8W	28480	0757-0932
A5R5	0757-0946	2	R:FXD FLM 8.2K OHM 2% 1/8W	28480	0757-0946
A5R6	0757-0911	2	R:FXD FLM 300 OHM 2% 1/8W	28480	0757-0911
A5R7	0757-0917	1	R:FXD FLM 510 OHM 2% 1/8W	28480	0757-0917
A5R8	0757-0910	1	R:FXD FLM 270 OHM 2% 1/8W	28480	0757-0910
MISC	05087-00005	1+	SHIELD: P.C. BOARD	28480	05087-00005

See introduction to this section for ordering information

Table 6-2. Replaceable Parts (Continued)

Reference Designation	HP Part Number	Qty	Description	Mfr Code	Mfr Part Number
A6	05087-60005		BOARD ASSY:DIV. 5/1MHZ (USED WITH OPT 005)	28480	05087-60005
A6C1	0150-0093	3	C:FXD CER 0.01 UF +80-20% 100VDCW	72982	801-K800011
A6C2	0140-0198	2	C:FXD 200 PF 300 VDCW	72982	0140-0198
A6C3	0150-0093		C:FXD CER .01 UF +80-20% 100 VDCW	72982	801-K800011
A6C4	0180-0116	1	C:FXD ELECT 6.8 UF 10% 35VDCW	56289	150D685X903582-DYS
A6C5	0180-0117	3	C:FXD ELECT 2.7 UF 10%	28480	0180-0117
A6C6	0180-0117		C:FXD ELECT 2.7 UF 10% 35VDCW	28480	0180-0117
A6C7	0140-0198		C:FXD 200 PF, 300 VDCW	72982	0140-0198
A6C8	0140-0196	1	C:FXD. 150 PF, 300 VDCW	72982	0140-0196
A6C9	0150-0093		C:FXD CER .01 UF +80-20% 100 VDCW	72982	0150-0093
A6C10	0160-2224	1	C:FXD MICA 1800 PF, 5%	28480	0160-2224
A6C11	0180-0117	1	C:FXD ELECT 2.7 UF 10% 35VDCW	28480	0180-0117
A6C11	1902-3104	1	DIODE:BREAKDOWN 5.62V 5%	04713	S210939-110
A6C12	1901-0040	2	DIODE:SILICON 30MA 30WV	07263	FDG1088
A6C13	1901-0040	2	DIODE:SILICON 30MA 30WV	07263	FDG1088
A6L1	9140-0138	1	COIL/CHOKE 180 UH 5%	28480	9140-0138
A6L2	9140-0129	1	COIL/CHOKE 220 UH	28480	9140-0129
A6L3	9100-2282	1	COIL/CHOKE 330 UH	28480	9100-2282
A6Q1	1854-0019	3	TSTR:SI NPN	28480	1854-0019
A6Q2	1854-0019		TSTR:SI NPN	28480	1854-0019
A6Q3	1854-0003	1	TSTR:SI NPN(SELECTED FROM 2N1711)	28480	1854-0003
A6Q4	1854-0019		TSTR:SI NPN	28480	1854-0019
A6R1	0757-0893	1	R:FXD FLM 51 OHM 2% 1/8W	28480	0757-0893
A6R2	0757-0939	1	R:FXD MET FLM 4.3K OHM 2% 1/8W	28480	0757-0939
A6R3	0757-0932	1	R:FXD FLM 2.2K OHM 2% 1/8W	28480	0757-0932
A6R4	0757-0920	1	R:FXD FLM 680 OHM 2% 1/8W	28480	0757-0920
A6R5	0757-0931	1	R:FXD FLM 2K OHM 2% 1/8W	28480	0757-0931
A6R6	0757-0928	1	R:FXD FLM 1.5K OHM 2% 1/8W	28480	0757-0928
A6R7	0757-0908	2	R:FXD FLM 220 OHM 2% 1/8W	28480	0757-0908
A6R8	0757-0923	1	R:FXD FLM 910 OHM 2% 1/8W	28480	0757-0923
A6R9	0757-0943	1	R:FXD FLM 6200 OHM 2% 1/8W	28480	0757-0943
A6R10	0757-0934	1	R:FXD FLM 2.7K OHM 2% 1/8W	28480	0757-0934
A6R11	0757-0917	2	R:FXD FLM 510 OHM 2% 1/8W	28480	0757-0917
A6R12	0757-0908		R:FXD FLM 220 OHM 2% 1/8W	28480	0757-0908
A6R13	0757-0917		R:FXD FLM 510 OHM 2% 1/8W	28480	0757-0917
A6T1	107A-9C	1	TRANSFORMER ASSY:1 MHZ	28480	107A-9C
A6U1	1820-0055	1	IC:TTL DECADE COUNTER 10 MHZ MIN.	01295	SN7490N
MISC.	05087-00005	1+	SHIELD: P.C. BOARD	28480	05087-00005
A7	05087-60006		BOARD ASSY:DIV. 1MHZ (USED WITH OPT 006)	28480	05087-60006
A7C1	0150-0093	2	C:FXD CER 0.01 UF +80-20% 100VDCW	72982	801-K800011
A7C2	0160-2735	1	C:FXD MICA 1000 PF 5% 100VDCW	28480	0160-2735
A7C3	0150-0093		C:FXD CER .01 UF +80-20% 100VDCW	72982	801-K800011
A7C4	0180-0116	1	C:FXD ELECT 6.8 UF 10% 35VDCW	56289	150D685X9035B2-DYS
A7C5	0180-0117	3	C:FXD ELECT 2.7 UF 10% 35VDCW	28480	0180-0117
A7C6	0180-0117		C:FXD ELECT 2.7 UF 10% 35VDCW	28480	0180-0117
A7C7	0160-2230	1	C:FXD MICA 3300 PF 1%	28480	0160-2230
A7C8	0160-2226	1	C:FXD MICA 2200 PF 5% 300VDCW	28480	0160-2226
A7C9	0150-0121	1	C:FXD CER .1 UF +80-20% 50VDCW	28480	0150-0121
A7C10	0140-0170	1	C:FXD MICA 5600 PF 300VDCW	28480	0140-0170
A7C12	0140-0184	1	C:FXD MICA 8200 PF 100VDCW	28480	0140-0184
A7C11	0180-0117		C:ELECT 2.7 UF 10% 35 VDCW	28480	0180-0117
A7CR1	1902-3104	1	DIODE:BREAKDOWN 5.62V 5%	04713	S210939-110
A7CR2	1901-0040	2	DIODE:SILICON 30MA 30WV	07263	FDG1088
A7CR3	1901-0040	2	DIODE:SILICON 30MA 30WV	07263	FDG1088
A7L1	9140-0138	1	COIL/CHOKE 180 UH 5%	28480	9140-0138
A7L2	9100-1650	1	COIL/CHOKE 680 UH 5%	28480	9100-1650
A7L3	9140-0137	1	COIL/CHOKE 1000 UH 5%	28480	9140-0137
A7O1	1854-0019	3	TSTR:SI NPN	28480	1854-0019
A7O2	1854-0019		TSTR:SI NPN	28480	1854-0019
A7O3	1854-0003	1	TSTR:SI NPN(SELECTED FROM 2N1711)	28480	1854-0003
A7O4	1854-0019		TSTR:SI NPN	28480	1854-0019
A7R1	0757-0893	1	R:FXD FLM 51 OHM 2% 1/8W	28480	0757-0893
A7R2	0757-0939	1	R:FXD MET FLM 4.3K OHM 2% 1/8W	28480	0757-0939
A7R3	0757-0932	1	R:FXD FLM 2.2K OHM 2% 1/8W	28480	0757-0932
A7R4	0757-0920	1	R:FXD FLM 608 OHM 2% 1/8W	28480	0757-0920
A7R5	0757-0931	1	R:FXD FLM 2K OHM 2% 1/8W	28480	0757-0931
A7R6	0757-0928	1	R:FXD MET FLM 1.5K OHM 2% 1/8W	28480	0757-0928
A7R7	0757-0908	2	R:FXD FLM 220 OHM 2% 1/8W	28480	0757-0908
A7R8	0757-0914	1	R:FXD FLM 390 OHM 2% 1/8W	28480	0757-0914
A7R9	0757-0943	1	R:FXD FLM 6.2K OHM 2% 1/8W	28480	0757-0943
A7R10	0757-0934	1	R:FXD FLM 2.7K OHM 2% 1/8W	28480	0757-0934
A7R11	0757-0917	2	R:FXD FLM 510 OHM 2% 1/8W	28480	0757-0917
A7R12	0757-0908		R:FXD FLM 220 OHM 2% 1/8W	28480	0757-0908
A7R13	0757-0917		R:FXD FLM 510 OHM 2% 1/8W	28480	0757-0917
A7T1	107A-9C	1	TRANSFORMER ASSY:100KHZ	28480	107A-9C
A7U1	1820-0055	1	IC:TTL DECADE COUNTER 10 MHZ MIN.	01295	SN7490N
MISC	05087-00005	1+	SHIELD: P.C. BOARD	28480	05087-00005

See introduction to this section for ordering information

Table 6-2. Replaceable Parts (Continued)

Reference Designation	HP Part Number	Qty	Description	Mfr Code	Mfr Part Number
A8	05087-60001		BOARD ASSY:AMP, 5MHZ (USED WITH OPT 001)	28480	05087-60001
A8C1	0150-0121	3	C:FXD CER 0.1 UF +80-20% 50VDCW	56289	5C50BIS-CML
A8C2	0180-0117	5	C:FXD ELECT 2.7 UF 10% 35VDCW	28480	0180-0117
A8C3	0150-0121		C:FXD CER 0.1 UF +80-20% 50VDCW	56289	5C50BIS-CML
A8C4	0180-0117		C:FXD ELECT 2.7 UF 10% 35VDCW	28480	0180-0117
A8C5	0150-0121		C:FXD CER 0.1 UF +80-20% 50VDCW	56289	5C50BIS-CML
A8C6	0160-0337	2	C:FXD MICA 160 PF 1% NOT ASSIGNED	28480	0160-0337
A8C7					
A8C8	0180-0117		C:FXD ELECT 2.7 UF 10% 35VDCW	28480	0180-0117
A8C9	0160-0337		C:FXD MICA 160 PF 1%	28480	0160-0337
A8C10			NOT ASSIGNED		
A8C11	0180-0117		C:FXD ELECT 2.7 UF 10% 35VDCW	28480	0180-0117
A8C12	0180-0117		C:FXD ELECT 2.7 UF 10% 35VDCW	28480	0180-0117
A8CR1	1901-0033	1	DIODE:SILICON 100MA 180MV	07263	F03369
A8CR2	1901-0040	1	DIODE:SILICON 30MA 30MV	07263	F061088
A8L1	9140-0138	1	COIL/CHOKE 180 UH 5%	28480	9140-0138
A8Q1	1854-0019	2	TSTR:SI NPN	28480	1854-0019
A8Q2	1854-0019		TSTR:SI NPN	28480	1854-0019
A8Q3	1854-0053	2	TSTR:SI NPN	80131	2N2218
A8Q4	1854-0053		TSTR:SI NPN	80131	2N2218
A8R1	2100-2633	1	R:VAR CERMET 1K OHM 10% LIN 1/2W	28480	2100-2633
A8R2	0757-0950	1	R:FXD FLM 12K OHM 2% 1/8W	28480	0757-0950
A8R3	0757-0940	1	R:FXD FLM 4700 OHM 2% 1/8W	28480	0757-0940
A8R4	0757-0917	2	R:FXD FLM 510 OHM 2% 1/8W	28480	0757-0917
A8R5	0757-0914	1	R:FXD FLM 390 OHM 2% 1/8W	28480	0757-0914
A8R6	0757-0900	2	R:FXD MET FLM 100 OHM 2% 1/8W	28480	0757-0900
A8R7	0757-0900		R:FXD MET FLM 100 OHM 2% 1/8W	28480	0757-0900
A8R8	0757-0928	1	R:FXD FLM 1.5K OHM 2% 1/8W	28480	0757-0928
A8R9	0757-0893	3	R:FXD FLM 51 OHM 2% 1/8W	28480	0757-0893
A8R10	0757-0941	1	R:FXD FLM 5.1K OHM 2% 1/8W	28480	0757-0941
A8R11	0757-0893		R:FXD FLM 51 OHM 2% 1/8W	28480	0757-0893
A8R12	0757-0893		R:FXD FLM 51 OHM 2% 1/8W	28480	0757-0893
A8R13	2100-1768	1	R:VAR WM 20 OHM 5% TYPE H 1W	28480	2100-1768
A8R14	0757-0917		R:FXD FLM 510 OHM 2% 1/8W	28480	0757-0917
A8R15	0757-0948	1	R:FXD FLM 10K OHM 2% 1/8W	28480	0757-0948
A8T1	05087-80001	2	TRANSFORMER ASSY:5 MHZ	28480	05087-80001
A8T2	05087-80001		TRANSFORMER ASSY:5 MHZ	28480	05087-80001
MISC	05087-00005	1+	SHIELD: PC BOARD	28480	05087-00005
A9	05087-60002		BOARD ASSY:AMP, 1MHZ (USED WITH OPT 002)	28480	05087-60002
A9C1	0150-0121	3	C:FXD CER 0.1 UF +80-20% 50VDCW	56289	5C50BIS-CML
A9C2	0180-0117	5	C:FXD ELECT 2.7 UF 10% 35VDCW	28480	0180-0117
A9C3	0150-0121		C:FXD CER 0.1 UF +80-20% 50VDCW	56289	5C50BIS-CML
A9C4	0180-0117		C:FXD ELECT 2.7 UF 10% 35VDCW	28480	0180-0117
A9C5	0150-0121		C:FXD CER 0.1 UF +80-20% 50VDCW	56289	5C50BIS-CML
A9C6	0160-0342	2	C:FXD MICA 800 PF 1% 300VDCW NOT ASSIGNED	04062	RDM15F801F3C
A9C7					
A9C8	0180-0117		C:FXD ELECT 2.7 UF 10% 35VDCW	28480	0180-0117
A9C9	0160-0342		C:FXD MICA 800 PF 1% 300VDCW	04062	RDM15F801F3C
A9C10			NOT ASSIGNED		
A9C11	0180-0117		C:FXD ELECT 2.7 UF 10% 35VDCW	28480	0180-0117
A9C12	0180-0117		C:FXD ELECT 2.7 UF 10% 35VDCW	28480	0180-0117
A9CR1	1901-0033	1	DIODE:SILICON 100MA 180MV	07263	F03369
A9CR2	1901-0040	1	DIODE:SILICON 30MA 30MV	07263	F061088
A9L1	9140-0138	1	COIL/CHOKE 180 UH 5%	28480	9140-0138
A9Q1	1854-0019	2	TSTR:SI NPN	28480	1854-0019
A9Q2	1854-0019		TSTR:SI NPN	28480	1854-0019
A9Q3	1854-0053	2	TSTR:SI NPN	80131	2N2218
A9Q4	1854-0053		TSTR:SI NPN	80131	2N2218
A9R1	2100-2633	1	R:VAR CERMET 1K OHM 10% LIN 1/2W	28480	2100-2633
A9R2	0757-0950	1	R:FXD FLM 12K OHM 2% 1/8W	28480	0757-0950
A9R3	0757-0940	1	R:FXD FLM 4700 OHM 2% 1/8W	28480	0757-0940
A9R4	0757-0917	2	R:FXD FLM 510 OHM 2% 1/8W	28480	0757-0917
A9R5	0757-0914	1	R:FXD FLM 390 OHM 2% 1/8W	28480	0757-0914
A9R6	0757-0900	2	R:FXD MET FLM 100 OHM 2% 1/8W	28480	0757-0900
A9R7	0757-0900		R:FXD MET FLM 100 OHM 2% 1/8W	28480	0757-0900
A9R8	0757-0928	1	R:FXD FLM 1.5K OHM 2% 1/8W	28480	0757-0928
A9R9	0757-0893	3	R:FXD FLM 51 OHM 2% 1/8W	28480	0757-0893
A9R10	0757-0941	1	R:FXD FLM 5.1K OHM 2% 1/8W	28480	0757-0941
A9R11	0757-0893		R:FXD FLM 51 OHM 2% 1/8W	28480	0757-0893
A9R12	0757-0893		R:FXD FLM 51 OHM 2% 1/8W	28480	0757-0893
A9R13	2100-1768	1	R:VAR WM 20 OHM 5% TYPE H 1W	28480	2100-1768
A9R14	0757-0917		R:FXD FLM 510 OHM 2% 1/8W	28480	0757-0917
A9R15	0757-0948	1	R:FXD FLM 10K OHM 2% 1/8W	28480	0757-0948
A9T1	05087-80002	2	TRANSFORMER ASSY:1 MHZ	28480	05087-80002
A9T2	05087-80002		TRANSFORMER ASSY:1 MHZ	28480	05087-80002
MISC	05087-00005	1+	SHIELD: P.C. BOARD	28480	05087-00005

See introduction to this section for ordering information

Table 6-2. Replaceable Parts (Continued)

Reference Designation	HP Part Number	Qty	Description	Mfr Code	Mfr Part Number
A10	05087-60003		BOARD ASSY:AMP 100KHZ (USED WITH OPN 003)	28480	05087-60003
A10C1	0150-0121	3	C:FXD CER 0.1 UF +80-20% 50VDCW	56289	5C50B1S-CML
A10C2	0180-0117	5	C:FXD ELECT 2.7 UF 10% 35VDCW	28480	0180-0117
A10C3	0150-0121		C:FXD CER 0.1 UF +80-20% 50VDCW	56289	5C50B1S-CML
A10C4	0180-0117		C:FXD ELECT 2.7 UF 10% 35VDCW	28480	0180-0117
A10C5	0150-0121		C:FXD CER 0.1 UF +80-20% 50VDCW	56289	5C50B1S-CML
A10C6	0140-0170	4	C:FXD MICA 5600 PF 5% 300VDCW	28480	0140-0170
A10C7	0140-0170		C:FXD MICA 5600 PF 5% 300VDCW	28480	0140-0170
A10C8	0180-0117		C:FXD ELECT 2.7 UF 10% 35VDCW	28480	0180-0117
A10C9	0140-0170		C:FXD MICA 5600 PF 5% 300VDCW	28480	0140-0170
A10C10	0140-0170		C:FXD MICA 5600 PF 5% 300VDCW	28480	0140-0170
A10C11	0180-0117		C:FXD ELECT 2.7 UF 10% 35VDCW	28480	0180-0117
A10C12	0180-0117		C:FXD ELECT 2.7 UF 10% 35VDCW	28480	0180-0117
A10CR1	1901-0033	1	DIODE:SILICON 100MA 180MV	07263	FDG1088
A10CR2	1901-0040	1	DIODE:SILICON 30MA 300MV	07263	FDG1088
A10Q1	1854-0019	2	TSTR:SI NPN	28480	1854-0019
A10Q2	1854-0019		TSTR:SI NPN	28480	1854-0019
A10Q3	1854-0053	2	TSTR:SI NPN	80131	2N2218
A10Q4	1854-0053		TSTR:SI NPN	80131	2N2218
A10R1	2100-2633	1	R:VAR CERMET 1K OHM 10% LIN 1/2W	28480	2100-2633
A10R2	0757-0950	1	R:FXD FLM 12K OHM 2% 1/8W	28480	0757-0950
A10R3	0757-0940	1	R:FXD FLM 4700 OHM 2% 1/8W	28480	0757-0940
A10R4	0757-0917	2	R:FXD FLM 510 OHM 2% 1/8W	28480	0757-0917
A10R5	0757-0914	1	R:FXD FLM 390 OHM 2% 1/8W	28480	0757-0914
A10R6	0757-0898	2	R:FXD MET FLM 82 OHM 2% 1/8W	28480	0757-0898
A10R7	0757-0900		R:FXD MET FLM 82 OHM 2% 1/8W	28480	0757-0900
A10R8	0757-0928	1	R:FXD FLM 1.5K OHM 2% 1/8W	28480	0757-0928
A10R9	0757-0893	3	R:FXD FLM 51 OHM 2% 1/8W	28480	0757-0893
A10R10	0757-0941	1	R:FXD FLM 5.1K OHM 2% 1/8W	28480	0757-0941
A10R11	0757-0893		R:FXD FLM 51 OHM 2% 1/8W	28480	0757-0893
A10R12	0757-0893		R:FXD FLM 51 OHM 2% 1/8W	28480	0757-0893
A10R13	2100-1768	1	R:VAR WW 20 OHM 5% TYPE H 1W	28480	2100-1768
A10R14	0757-0917		R:FXD FLM 510 OHM 2% 1/8W	28480	0757-0917
A10R15	0757-0948	1	R:FXD FLM 10K OHM 2% 1/8W	28480	0757-0948
A10T1	05087-80003	2	TRANSFORMER ASSY:100 KHZ	28480	05087-80003
A10T2	05087-80003		TRANSFORMER ASSY:100 KHZ	28480	05087-80003
MISC	05087-00005	1+	SHIELD: P.C. BOARD	28480	05087-00005
A11	05087-60011	1	BOARD ASSY:5 MHZ TO 10 MHZ DOUBLEK (USED WITH OPTION 011)	28480	05087-60011
A11	05087-00005	1	SHIELD:BOARD	28480	05087-00005
A11C1	0150-0093	8	C:FXD CER 0.01 UF +80-20% 100VDCW	72982	801-K800011
A11C2	0150-0093		C:FXD CER 0.01 UF +80-20% 100VDCW	72982	801-K800011
A11C3	0150-0093		C:FXD CER 0.01 UF +80-20% 100VDCW	72982	801-K800011
A11C4	0150-0093		C:FXD CER 0.01 UF +80-20% 100VDCW	72982	801-K800011
A11C5	0150-0093		C:FXD CER 0.01 UF +80-20% 100VDCW	72982	801-K800011
A11C6	0180-1746	1	C:FXD ELECT 15 UF 10% 20VDCW	28480	0180-1746
A11C7	0121-0180	2	C:VAR CER 15-60 PF	28480	0121-0180
A11C8	0140-0178	1	C:FXD MICA 560 PF 5%	28480	0140-0178
A11C9	0150-0093		C:FXD CER 0.01 UF +80-20% 100VDCW	72982	801-K800011
A11C10	0160-0369	1	C:FXD MICA 17 PF 5%	28480	0160-0369
A11C11	0140-0201	1	C:FXD MICA 12 PF 5%	28480	0140-0201
A11C12	0150-0093		C:FXD CER 0.01 UF +80-20% 100VDCW	72982	801-K800011
A11C13	0121-0105	7	C:VAR CER 9-35 PF NPO	28480	0121-0105
A11C14	0160-0205	1	C:FXD MICA 10 PF 5%	28480	0160-0205
A11C15	0150-0093		C:FXD CER 0.01 UF +80-20% 100VDCW	72982	801-K800011
A11C16	0160-2198	1	C:FXD MICA 20 PF 5%	72136	RDML5C200J3C
A11C17	0121-0180		C:VAR CER 15-60 PF	28480	0121-0180
A11C18	0140-0193	1	C:FXD MICA 82 PF 5%	28480	0140-0193
A11C19	0180-0117	1	C:FXD ELECT 2.7 UF 10% 35VDCW	28480	0180-0117
A11CR1	1901-0040	3	DIODE:SILICON 50 MA 30 MV	07263	FDG1088
A11CR2	1901-0040		DIODE:SILICON 50 MA 30 MV	07263	FDG1088
A11CR3	1901-0347	2	DIODE:SILICON 8V	28480	1901-0347
A11CR4	1901-0347		DIODE:SILICON 8V	28480	1901-0347
A11CR5	1901-0040		DIODE:SILICON 50 MA 30 MV	07263	FDG1088
A11L1	9100-1621	3	COIL/CHOKE 18.0 UH 10%	99800	1537-42
A11L2	9100-1621		COIL/CHOKE 18.0 UH 10%	99800	1537-42
A11L4	9100-1621		COIL/CHOKE 18.0 UH 10%	99800	1537-42
A11L5	9140-0178		COIL:FXD 12 UH 10%	28480	9140-0178
A11L6	9100-2260	1	COIL:FXD 1.80 UH 10%	82142	09-4456-3K

See introduction to this section for ordering information

Table 6-2. Replaceable Parts (Continued)

Reference Designation	HP Part Number	Qty	Description	Mfr Code	Mfr Part Number
A1101 A1102 A1103 A1104 A11R1	1853-0034 1853-0034 1853-0034 1853-0034 0757-0893	4 1	TSTR:SI PNP(SELECTED FROM 2N3251) TSTR:SI PNP(SELECTED FROM 2N3251) TSTR:SI PNP(SELECTED FROM 2N3251) TSTR:SI PNP(SELECTED FROM 2N3251) R:FXD FLM 51 OHM 2% 1/8W	28480 28480 28480 28480 28480	1853-0034 1853-0034 1853-0034 1853-0034 0757-0893
A11R2 A11R3 A11R4 A11R5 A11R6	0757-0924 0757-0932 0757-0932 0757-0940 0757-0932	3 4 1	R:FXD MET FLM 1K OHM 2% 1/8W R:FXD MET FLM 2.2K OHM 2% 1/8W R:FXD MET FLM 2.2K OHM 2% 1/8W R:FXD FLM 4700 OHM 2% 1/8W R:FXD MET FLM 2.2K OHM 2% 1/8W	28480 28480 28480 28480 28480	0757-0924 0757-0932 0757-0932 0757-0940 0757-0932
A11R7 A11R8 A11R9 A11R10 A11R11	0757-0924 0757-0921 0757-0955 0757-0932 0757-0924	1 1 1 1 1	R:FXD MET FLM 1K OHM 2% 1/8W R:FXD MET FLM 750 OHM 2% 1/8W R:FXD FLM 20K OHM 2% 1/8W R:FXD MET FLM 2.2K OHM 2% 1/8W R:FXD MET FLM 1K OHM 2% 1/8W	28480 28480 28480 28480 28480	0757-0924 0757-0921 0757-0955 0757-0932 0757-0924
A11R12 A11R13 A11R14 A11R15 A11R16	0757-0948 0757-0928 0757-0909 0757-0907 0757-0917	1 1 1 1 1	R:FXD FLM 10K OHM 2% 1/8W R:FXD FLM 1.5K OHM 2% 1/8W R:FXD FLM 240 OHM 2% 1/8W R:FXD FLM 200 OHM 2% 1/8W R:FXD FLM 510 OHM 2% 1/8W	28480 28480 28480 28480 28480	0757-0948 0757-0928 0757-0909 0757-0907 0757-0917
A11T1	05065-8014	1	TRANSFORMER:5-10MHZ	28480	05065-8014
A12	05087-60012	1	BOARD ASSY: AMP 10 MHz (SERIES 1620) (USED WITH OPTION 012)	28480	05087-60012
A12 A12C1 A12C2 A12C3 A12C4	05087-00005 0150-0121 0180-0117 0150-0121 0180-0117	1 5 5	SHIELD:BOARD C:FXD CER 0.1 UF +80-20% 50VDCW C:FXD ELECT 2.7 UF 10% 35VDCW C:FXD CER 0.1 UF +80-20% 50VDCW C:FXD ELECT 2.7 UF 10% 35VDCW	28480 56289 28480 56289 28480	05087-00005 5C5081S-CML 0180-0117 5C5081S-CML 0180-0117
A12C5 A12C6 A12C7 A12C8 A12C9	0150-0121 0140-0145 0180-0117 0140-0145	2	C:FXD CER 0.1 UF +80-20% 50VDCW C: FXD MICA 22 PF 5% 500 VDW NOT ASSIGNED C:FXD ELECT 2.7 UF 10% 35VDCW C: FXD MICA 22 PF 5% 500 VDCW	56289 28480 28480 28480	5C5081S-CML 0140-0145 0180-0117 0140-0145
A12C10 A12C11 A12C12 A12CR1 A12CR2	0180-0117 0180-0117 1901-0033 1901-0040	1 1	NOT ASSIGNED C:FXD ELECT 2.7 UF 10% 35VDCW C:FXD ELECT 2.7 UF 10% 35VDCW DIODE:SILICON 100MA 180V DIODE:SILICON 50 MA 30 WV	28480 28480 07263 07263	0180-0117 0180-0117 FD3369 FDG1088
A12Q1 A12Q2 A12Q3 A12Q4 A12R1	1854-0019 1854-0019 1854-0053 1854-0053 2100-2633	2 2 1	TSTR:SI NPN TSTR:SI NPN TSTR:SI NPN TSTR:SI NPN R:VAR CERMET 1K OHM 10% LIN 1/2W	28480 28480 80131 80131 28480	1854-0019 1854-0019 2N2218 2N2218 2100-2633
A12R2 A12R3 A12R4 A12R5 A12R6	0757-0950 0757-0940 0757-0917 0757-0914 0757-0898	1 1 2 1 2	R:FXD FLM 12K OHM 2% 1/8W R:FXD FLM 4700 OHM 2% 1/8W R:FXD FLM 510 OHM 2% 1/8W R:FXD FLM 390 OHM 2% 1/8W R:FXD FLM 82 OHM 2% 1/8W	28480 28480 28480 28480 28480	0757-0950 0757-0940 0757-0917 0757-0914 0757-0898
A12R7 A12R8 A12R9 A12R10 A12R11	0757-0898 0757-0928 0757-0893 0757-0941 0757-0893	1 3 1	R:FXD FLM 82 OHM 2% 1/8W R:FXD FLM 1.5K OHM 2% 1/8W R:FXD FLM 51 OHM 2% 1/8W R:FXD FLM 5.1K OHM 2% 1/8W R:FXD FLM 51 OHM 2% 1/8W	28480 28480 28480 28480 28480	0757-0898 0757-0928 0757-0893 0757-0941 0757-0893
A12R12 A12R13 A12R14 A12R15 A12T1	0757-0893 2100-1768 0757-0917 0757-0948 05087-80001	1 1 1 1 2	R:FXD FLM 51 OHM 2% 1/8W R:VAR WW 20 OHM 5% TYPE H 1W R:FXD FLM 510 OHM 2% 1/8W R:FXD FLM 10K OHM 2% 1/8W TRANSFORMER ASSY:5 MHZ	28480 28480 28480 28480 28480	0757-0893 2100-1768 0757-0917 0757-0948 05087-80001
A12T2	05087-80001	1	TRANSFORMER ASSY:5 MHZ	28480	05087-80001

See introduction to this section for ordering information

Table 6-2. Replaceable Parts (Continued)

Reference Designation	HP Part Number	Qty	Description	Mfr Code	Mfr Part Number
A13	05087-60013	1	BOARD ASSY: 10 TO 5 MHZ DIVIDER (SERIES 1620) (USED WITH OPTION 013)	28480	05087-60013
A13	05087-00005	1	SHIELD:BOARD	28480	05087-00005
A13C1	0150-0093	3	C:FXD CER 0.01 UF +80-20% 100VDCW	72982	801-K800011
A13C2	0140-0198	1	C:FXD MICA 200 PF 5%	72136	RDM15F201J3C
A13C3	0150-0093	3	C:FXD CER 0.01 UF +80-20% 100VDCW	72982	801-K800011
A13C4	0180-0116	1	C:FXD ELECT 6.8 UF 10% 35VDCW	56289	1500685X903582-DYS
A13C5	0180-0117	3	C:FXD ELECT 2.7 UF 10% 35VDCW	28480	0180-0117
A13C6	0180-0117	3	C:FXD ELECT 2.7 UF 10% 35VDCW	28480	0180-0117
A13C7	0140-0190	2	C:FXD MICA 39 PF 5%	72136	RDM15E390J3C
A13C8	0140-0203	1	C:FXD MICA 30 PF 5%	28480	0140-0203
A13C9	0150-0093	3	C:FXD CER 0.01 UF +80-20% 100VDCW	72982	801-K800011
A13C10	0140-0191	1	C: FXD MICA 56 PF 5% 300 VDCW	28480	0140-0191
A13C11	0180-0117	3	C:FXD ELECT 2.7 UF 10% 35VDCW	28480	0180-0117
A13CR1	1902-3104	1	DIODE:BRKAKDOWN 5.62V 5%	04713	SZ10939-110
A13CR2	1901-0040	2	DIODE:SILICON 50 MA 30 WV	07263	FDG1088
A13CR3	1901-0040	2	DIODE:SILICON 50 MA 30 WV	07263	FDG1088
A13L2	9100-1629	1	COIL/CHOKE 47.0 UH 5%	28480	9100-1629
A13L3	9100-1633	1	COIL/CHOKE 68.0 UH 5%	99800	1537-68
A13Q1	1854-0019	3	TSTR:SI NPN	28480	1854-0019
A13Q2	1854-0019	3	TSTR:SI NPN	28480	1854-0019
A13Q3	1854-0003	1	TSTR:SI NPN(SELECTED FROM 2N1711)	28480	1854-0003
A13Q4	1854-0019	3	TSTR:SI NPN	28480	1854-0019
A13R1	0757-0893	1	R:FXD FLM 51 OHM 2% 1/8W	28480	0757-0893
A13R2	0757-0939	1	R:FXD FLM 4.3K OHM 2% 1/8W	28480	0757-0939
A13R3	0757-0932	1	R:FXD MET FLM 2.2K OHM 2% 1/8W	28480	0757-0932
A13R4	0757-0920	1	R:FXD FLM 680 OHM 2% 1/8W	28480	0757-0920
A13R5	0757-0931	1	R:FXD FLM 2K OHM 2% 1/8W	28480	0757-0931
A13R6	0757-0928	1	R:FXD FLM 1.5K OHM 2% 1/8W	28480	0757-0928
A13R7	0757-0908	2	R:FXD FLM 220 OHM 2% 1/8W	28480	0757-0908
A13R8	0757-0923	1	R:FXD FLM 910 OHM 2% 1/8W	28480	0757-0923
A13R9	0757-0943	1	R:FXD FLM 6.2K OHM 2% 1/8W	28480	0757-0943
A13R10	0757-0934	1	R:FXD FLM 2.7K OHM 2% 1/8W	28480	0757-0934
A13R11	0757-0917	2	R:FXD FLM 510 OHM 2% 1/8W	28480	0757-0917
A13R12	0757-0908	2	R:FXD FLM 220 OHM 2% 1/8W	28480	0757-0908
A13R13	0757-0917	2	R:FXD FLM 510 OHM 2% 1/8W	28480	0757-0917
A13T1	107A-9H	1	TRANSFORMER ASSY:1 MHZ	28480	107A-9H
A13U1	1820-0055	1	IC:TTL DECADE COUNTER 10 MHZ MIN.	01295	SN7490N
A14	05087-60014	1	BOARD ASSY:10 TO 1 MHZ DIVIDER (USED WITH OPTION 014)	28480	05087-60014
A14	05087-00005	1	SHIELD:BOARD	28480	05087-00005
A14C1	0150-0093	3	C:FXD CER 0.01 UF +80-20% 100VDCW	72982	801-K800011
A14C2	0140-0198	2	C:FXD MICA 200 PF 5%	72136	RDM15F201J3C
A14C3	0150-0093	3	C:FXD CER 0.01 UF +80-20% 100VDCW	72982	801-K800011
A14C4	0180-0116	1	C:FXD ELECT 6.8 UF 10% 35VDCW	56289	1500685X903582-DYS
A14C5	0180-0117	3	C:FXD ELECT 2.7 UF 10% 35VDCW	28480	0180-0117
A14C6	0180-0117	3	C:FXD ELECT 2.7 UF 10% 35VDCW	28480	0180-0117
A14C7	0140-0198	2	C:FXD MICA 200 PF 5%	72136	RDM15F201J3C
A14C8	0140-0196	2	C:FXD MICA 150 PF 5%	72136	RDM15F151J3C
A14C9	0150-0093	3	C:FXD CER 0.01 UF +80-20% 100VDCW	72982	801-K800011
A14C10	0160-2224	1	C:FXD MICA 1800 PF 5%	28480	0160-2224
A14C11	0180-0117	3	C:FXD ELECT 2.7 UF 10% 35VDCW	28480	0180-0117
A14CR1	1902-3104	1	DIODE:BRKAKDOWN 5.62V 5%	04713	SZ10939-110
A14CR2	1901-0040	2	DIODE:SILICON 50 MA 30 WV	07263	FDG1088
A14CR3	1901-0040	2	DIODE:SILICON 50 MA 30 WV	07263	FDG1088
A14L2	9140-0129	1	COIL:FXD RF 220 UH	28480	9140-0129
A14L3	9100-2282	1	COIL/CHOKE 330 UH	28480	9100-2282
A14Q1	1854-0019	3	TSTR:SI NPN	28480	1854-0019
A14Q2	1854-0019	3	TSTR:SI NPN	28480	1854-0019
A14Q3	1854-0003	1	TSTR:SI NPN(SELECTED FROM 2N1711)	28480	1854-0003
A14Q4	1854-0019	3	TSTR:SI NPN	28480	1854-0019
A14R1	0757-0893	1	R:FXD FLM 51 OHM 2% 1/8W	28480	0757-0893
A14R2	0757-0939	1	R:FXD FLM 4.3K OHM 2% 1/8W	28480	0757-0939
A14R3	0757-0932	1	R:FXD MET FLM 2.2K OHM 2% 1/8W	28480	0757-0932
A14R4	0757-0920	1	R:FXD FLM 680 OHM 2% 1/8W	28480	0757-0920
A14R5	0757-0931	1	R:FXD FLM 2K OHM 2% 1/8W	28480	0757-0931
A14R6	0757-0928	1	R:FXD FLM 1.5K OHM 2% 1/8W	28480	0757-0928
A14R7	0757-0908	2	R:FXD FLM 220 OHM 2% 1/8W	28480	0757-0908
A14R8	0757-0923	1	R:FXD FLM 910 OHM 2% 1/8W	28480	0757-0923
A14R9	0757-0943	1	R:FXD FLM 6.2K OHM 2% 1/8W	28480	0757-0943
A14R10	0757-0934	1	R:FXD FLM 2.7K OHM 2% 1/8W	28480	0757-0934
A14R11	0757-0917	2	R:FXD FLM 510 OHM 2% 1/8W	28480	0757-0917
A14R12	0757-0908	2	R:FXD FLM 220 OHM 2% 1/8W	28480	0757-0908
A14R13	0757-0917	2	R:FXD FLM 510 OHM 2% 1/8W	28480	0757-0917
A14T1	107A-9H	1	TRANSFORMER ASSY:1 MHZ	28480	107A-9H
A14U1	1820-0055	1	IC:TTL DECADE COUNTER 10 MHZ MIN.	01295	SN7490N

See introduction to this section for ordering information

Table 6-3. Manufacturers Code List

MFR NO.	MANUFACTURER NAME	ADDRESS	ZIP CODE
00779	NO M/F DESCRIPTION FOR THIS MFG NUMBER AMP INC. (AIRCRAFT MARINE PROD.)	HARRISBURG, PA.	17101
01295	TEXAS INSTRUMENTS INC. SEMICONDUCTOR COMPONENTS DIV.	DALLAS, TEX.	75231
02735	RCA SOLID STATE & RECEIVING TUBE DIV.	SOMERVILLE, N.J.	08876
04062	NO M/F DESCRIPTION FOR THIS MFG NUMBER		
04713	MOTOROLA SEMICONDUCTOR PROD. INC.	PHOENIX, ARIZ.	85008
07263	FARCHILD CAMERA & INST. CORP. SEMICONDUCTOR DIV.	MOUNTAIN VIEW, CALIF.	94040
08806	G.E. CO. MINIATURE LAMP DEPT.	CLEVELAND, OHIO	44112
13103	THERMALLOY CO.	DALLAS, TEX.	75247
27251	SPECIALITIES MFG. CO. INC.	BRIDGEPORT, CONN.	06601
28480	HEWLETT-PACKARD CO. CORPORATE HQ	PALO ALTO, CALIF.	94304
56289	SPRAGUE ELECTRIC CO.	N. ADAMS, MASS.	01247
70903	BELDEN CORP.	CHICAGO, ILL.	60644
71468	ITT CANNON ELECT. INC.	LOS ANGELES, CALIF.	90031
71785	CINCH MFG. CO. DIV TRW INC.	ELK GROVE VILLAGE, ILL.	
72136	ELECTRO MOTIVE MFG. CO. INC.	WILLIMANTIC, CONN.	06226
72765	DRAKE MFG. CO.	HARWOOD HEIGHTS, ILL.	60656
72982	ERIE TECHNOLOGICAL PROD. INC.	ERIE, PA.	16512
75915	LITTELFUSE INC.	DES PLAINES, ILL.	60016
80131	ELECTRONIC INDUSTRIES ASSOCIATION	WASHINGTON D.C.	20006
82142	AIRCO SPEER ELECT. COMP.	DU BOIS, PA.	15801
91418	RADIO MATERIALS CO.	CHICAGO, ILL.	60646
91506	AUGAT INC.	ATTLEBORO, MASS.	02703
99800	DELEVAN ELECTRONICS CORP.	E. AURORA, N.Y.	14052

SECTION VII
MANUAL CHANGES AND OPTIONS

NOT USED

For Backdating and Options information, see Appendix A at the back of this manual.

SECTION VIII

CIRCUIT DIAGRAMS

8-1. GENERAL

8-2. This section contains schematic diagrams, waveforms, and component locators for the Model 5087A.

8-3. Shaded area on schematic diagrams indicate printed circuit board assemblies. Components within shaded areas are mounted on boards.

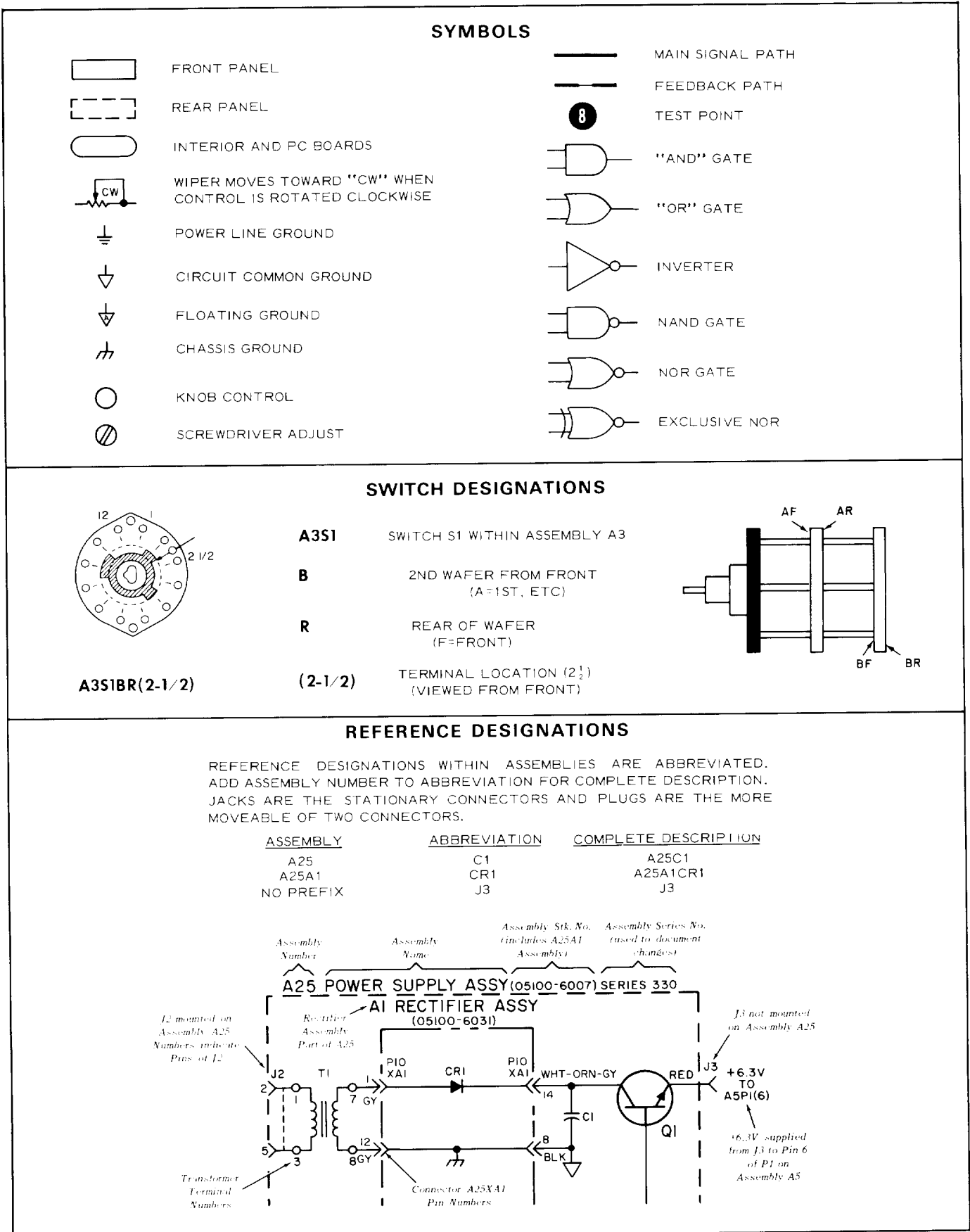
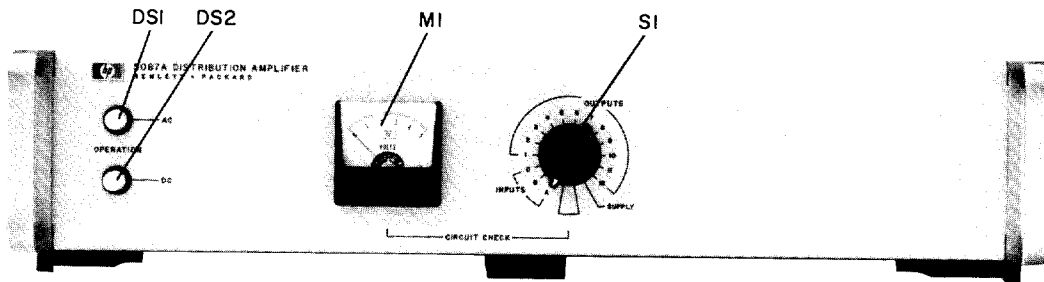
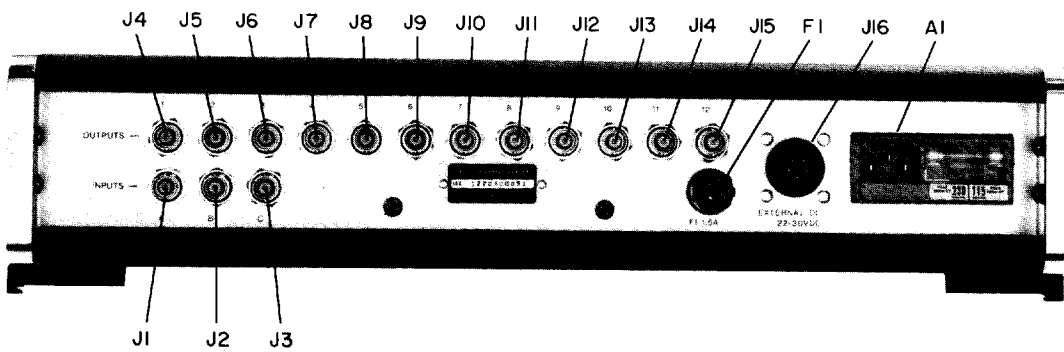

Figure 8-1. Schematic Diagram Notes

FRONT



REAR



Part of Figure 8-2. Model 5087A Front and Rear Panels

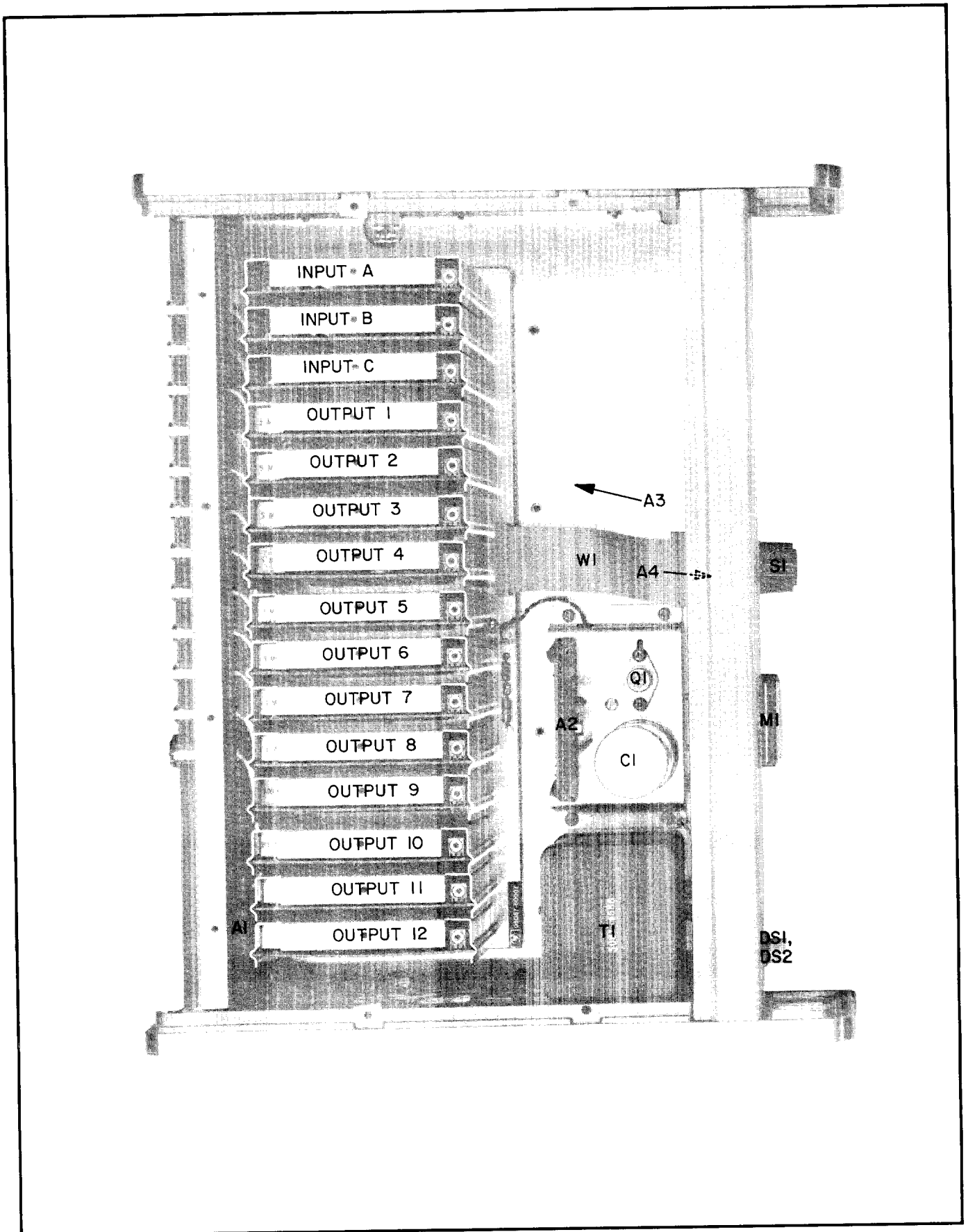

Part of Figure 8-2. Model 5087A Top View Shield Off

COMPONENTS INSIDE DOTTED LINE ARE INSTALLED ONLY ON SPECIAL ORDER.

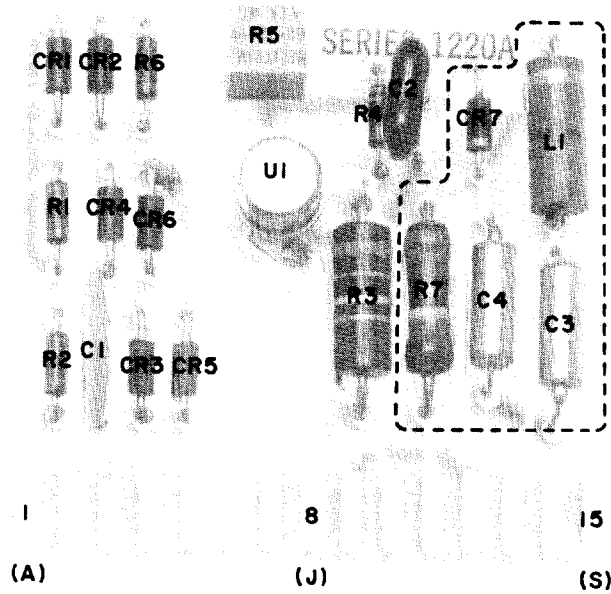

Part of Figure 8-2. A2 Power Supply Board

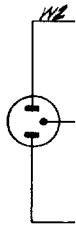
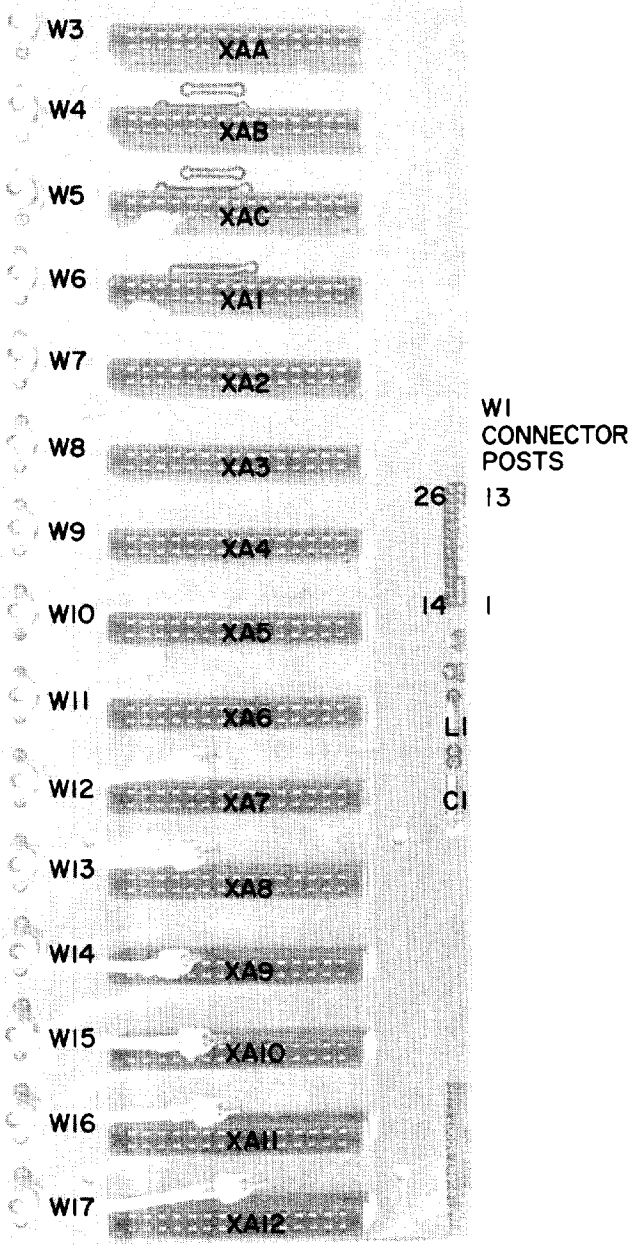

Figure 8-2
**A1 POWER MODULE ASSEMBLY, A2 POWER
SUPPLY ASSEMBLY, A3 MOTHER BOARD,
A4 CIRCUIT CHECK BOARD**

(See Page 8-7)



NOTE: W2 IS AC POWER CABLE

Part of Figure 8-3. A3 Mother Board

A3 MOTHER BOARD ASSEMBLY (05087-1)

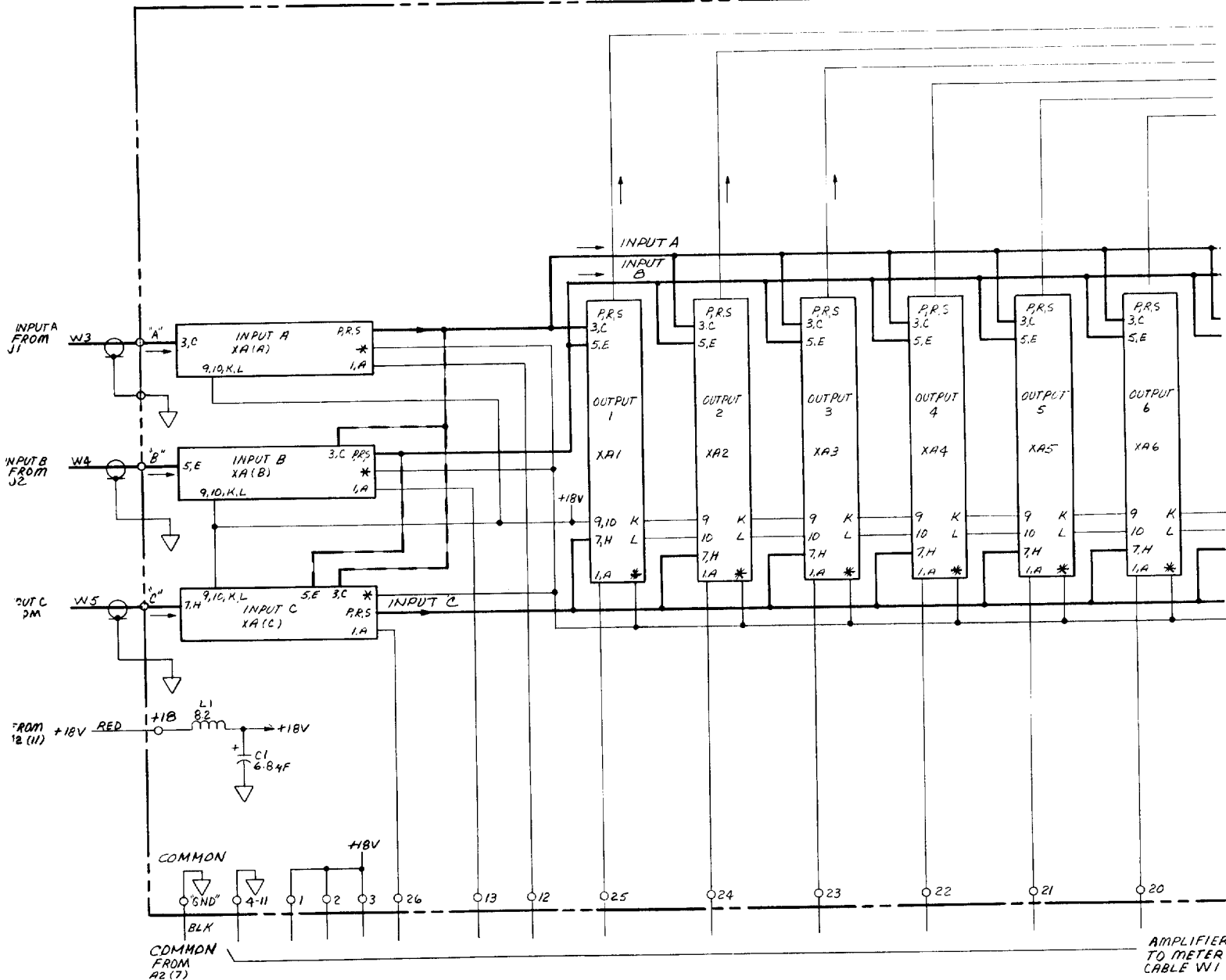

NOTES

1. REFERENCE DESIGNATIONS WITHIN THIS ASSEMBLY ARE ABBREVIATED. ADD ASSEMBLY NUMBER TO ABBREVIATION FOR COMPLETE DESCRIPTION.
2. UNLESS OTHERWISE INDICATED:
RESISTANCE IN OHMS;
CAPACITANCE IN PICO FARADS;
INDUCTANCE IN MICROHENRIES

+18V GND

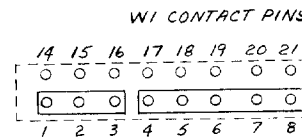

VIEW FROM COMPONENT SIDE WHILE FACING FRONT OF BOARD. RED STRIPE ON W1 CABLE NEAREST THE +18V AND GND

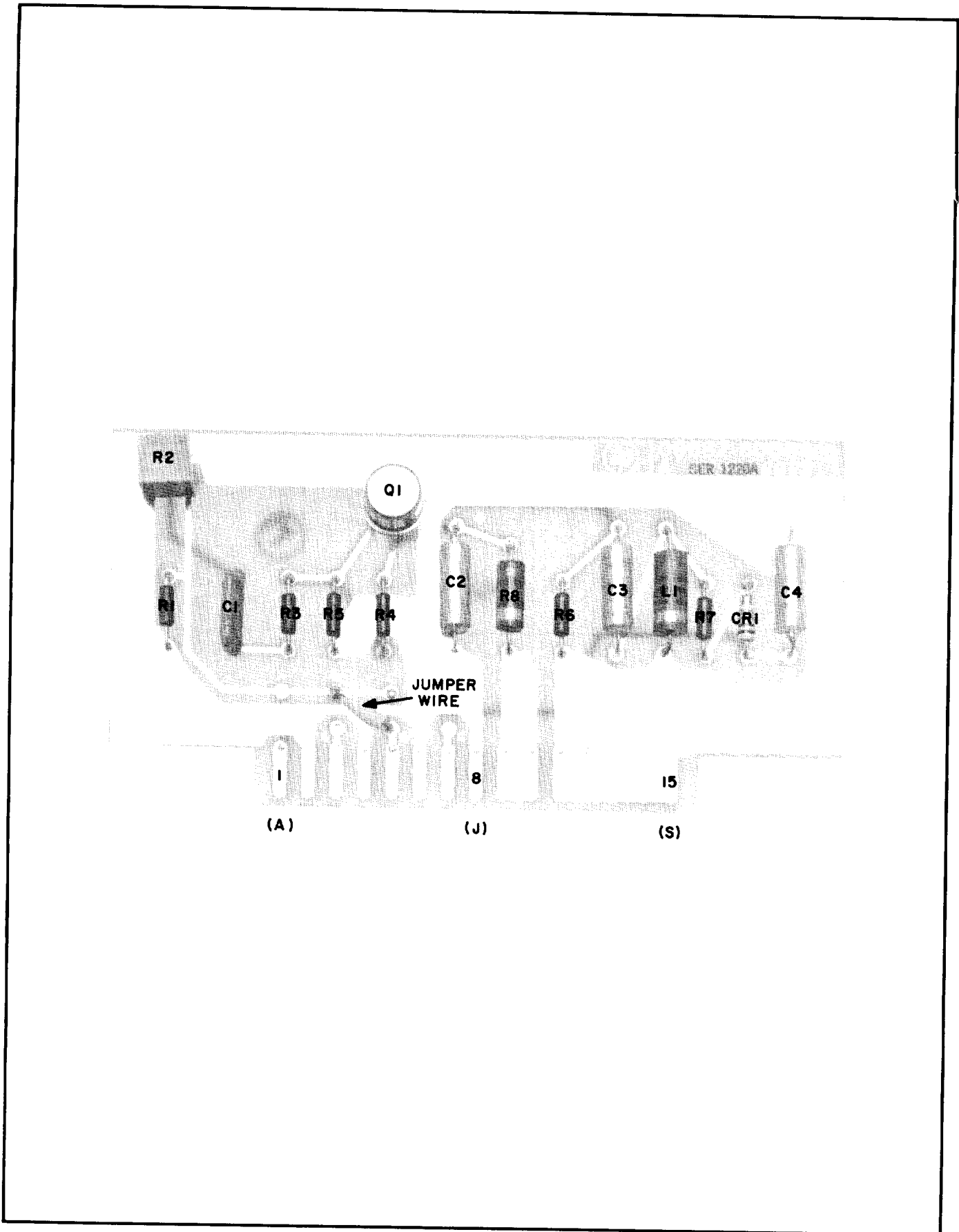

Part of Figure 8-4. A5 Input Amplifier

6007) SERIES 1240A AND 0507-60015 SERIES 1620

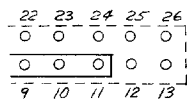
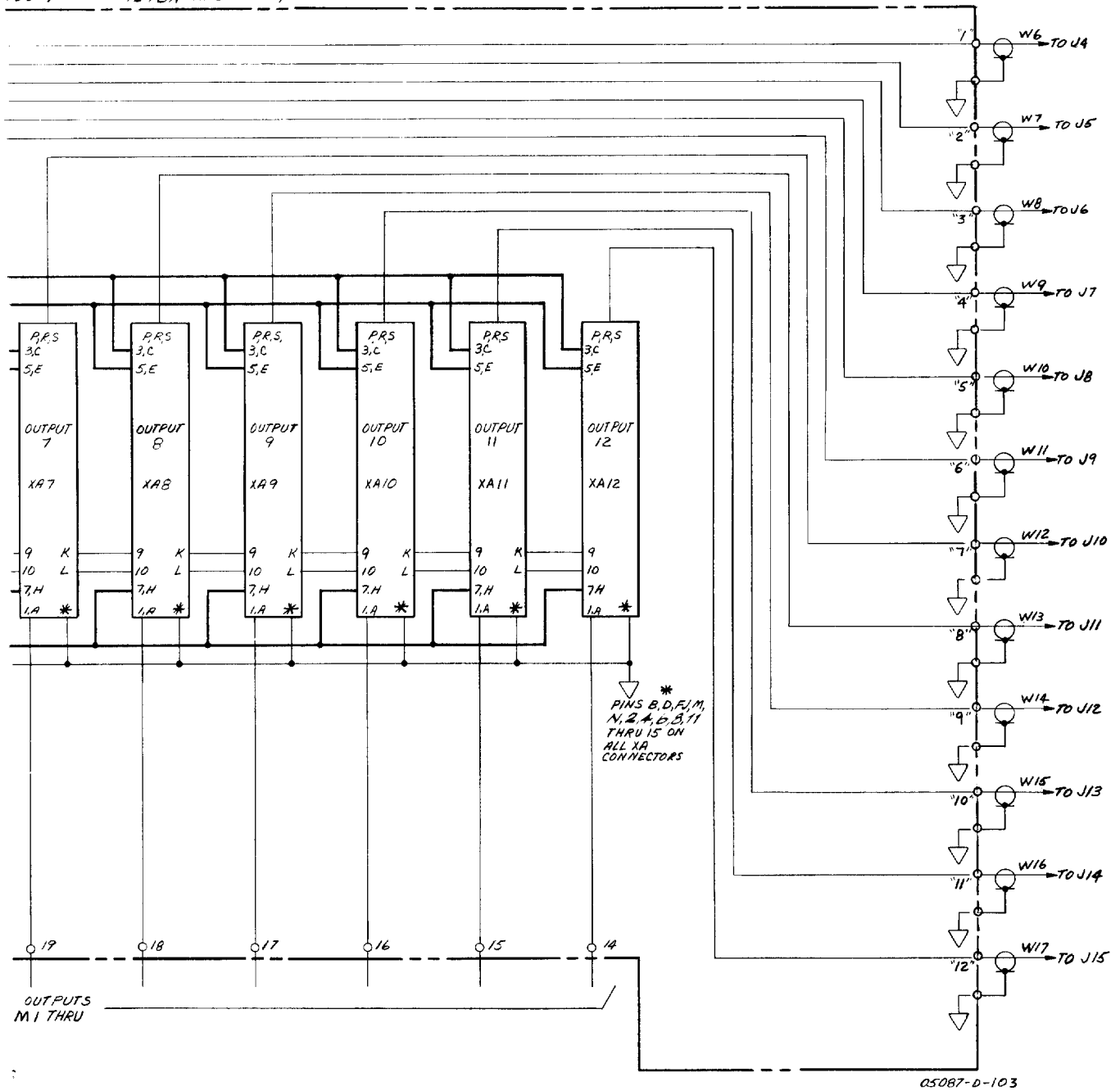

10E OF BOARD
TRUMENT
E 15
7 GND POSTS

Figure 8-3. A3 Mother Board

+18V
9, 10,
K, L

INPUTS FOR { INPUT A; 3, C
10 MHz, 5 MHz. INPUT B; 5, E
1 MHz OR 100 kHz INPUT C; 7, H
NOTE 3

TO A3 { 2, 4, 6, 8,
COMMON { 11-15
B, D, F, J,
M, N

COMPONENT LOCATOR FOR A6, A13 & A14

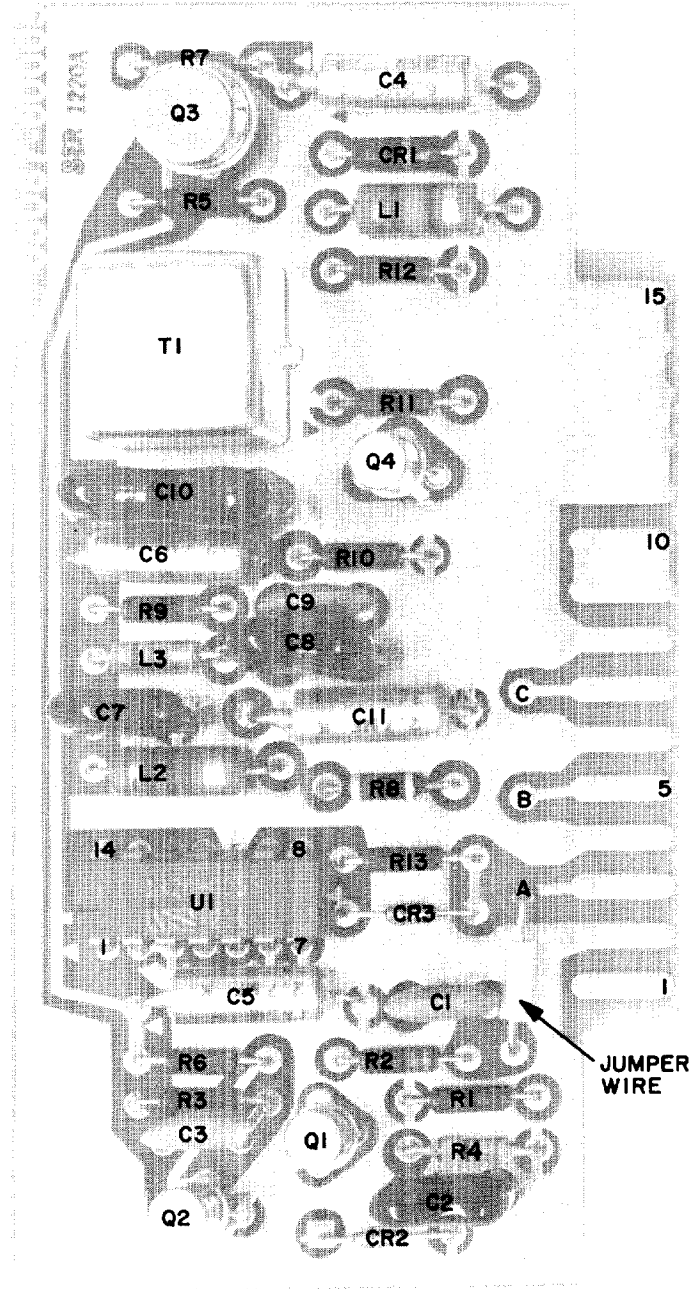

Part of Figure 8-5.

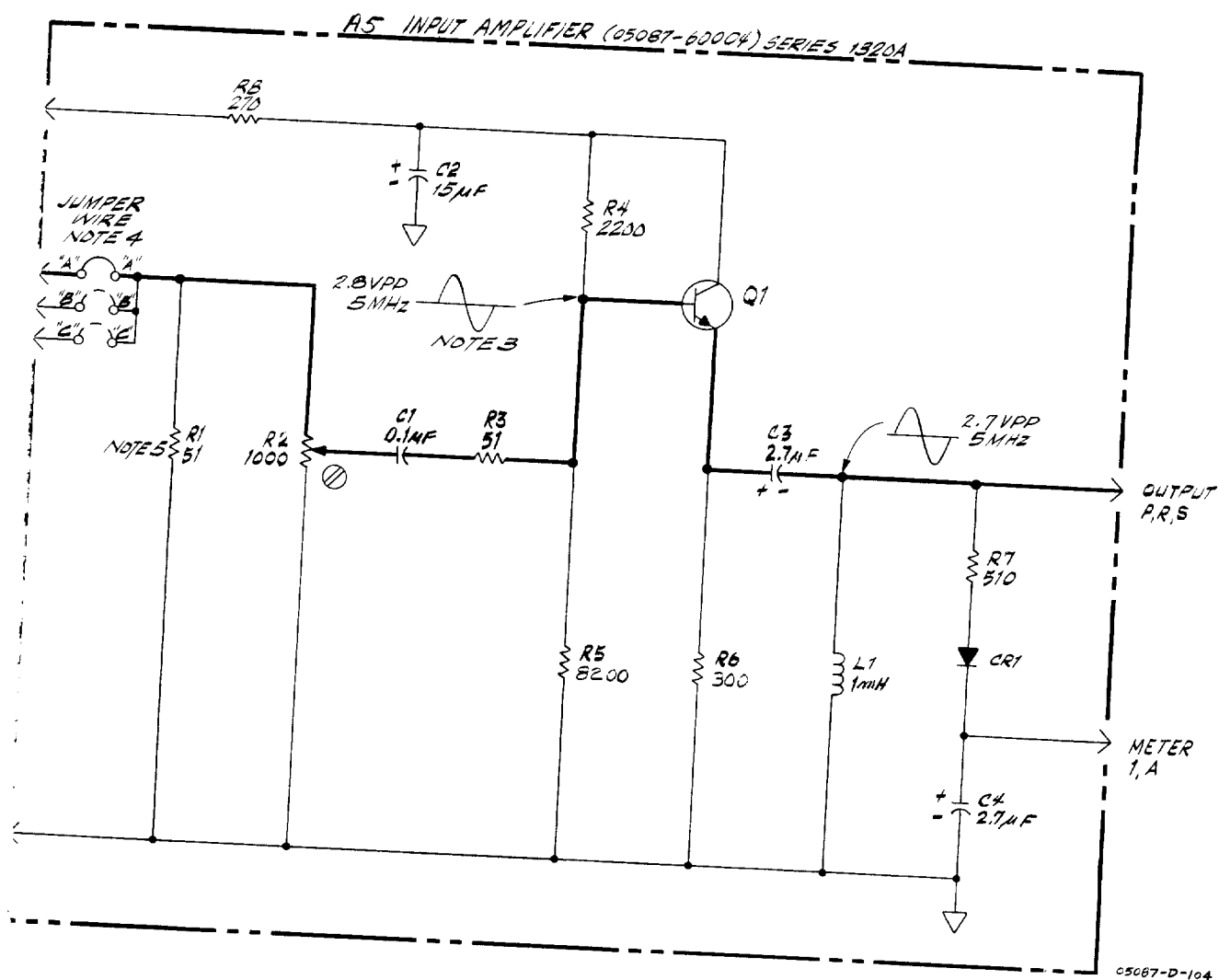

NOTES

1. REFERENCE DESIGNATIONS WITHIN THIS ASSEMBLY ARE ABBREVIATED. ADD ASSEMBLY NUMBER TO ABBREVIATION FOR COMPLETE DESCRIPTION.
2. UNLESS OTHERWISE INDICATED: RESISTANCE IN OHMS; CAPACITANCE IN PICOFARADS; INDUCTANCE IN MICROHENRIES
3. TEST INPUT: 5 MHz, 1V RMS.
4. JUMPER WIRE FOR SELECTING INPUT SIGNAL SOURCE. CONNECTION DEPENDS ON INPUT SOCKET IN WHICH BOARD IS INSTALLED AND DESIRED SIGNAL SOURCE. CONNECTION SHOWN IS FOR USE IN SOCKET A WITH INPUT FROM INPUT JACK J1 (INPUT A)
5. R1 MAY BE REMOVED TO GIVE 1000Ω INPUT IMPEDANCE.

Figure 8-4. A5 Input Amplifier

A6 5MHz TO 1MHz DIVIDER BOARD ASSEMBLY (C5087-600-5) SER

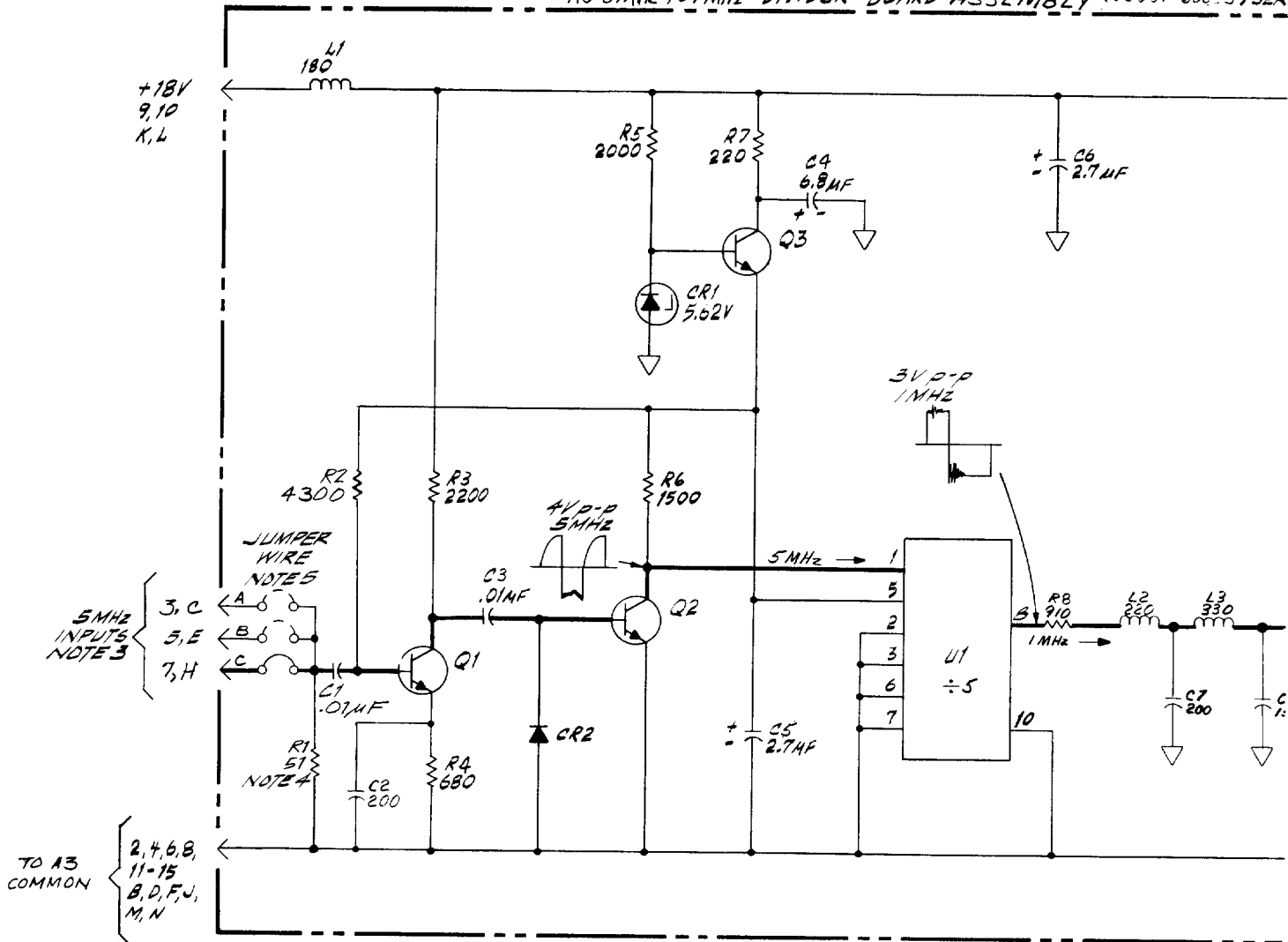

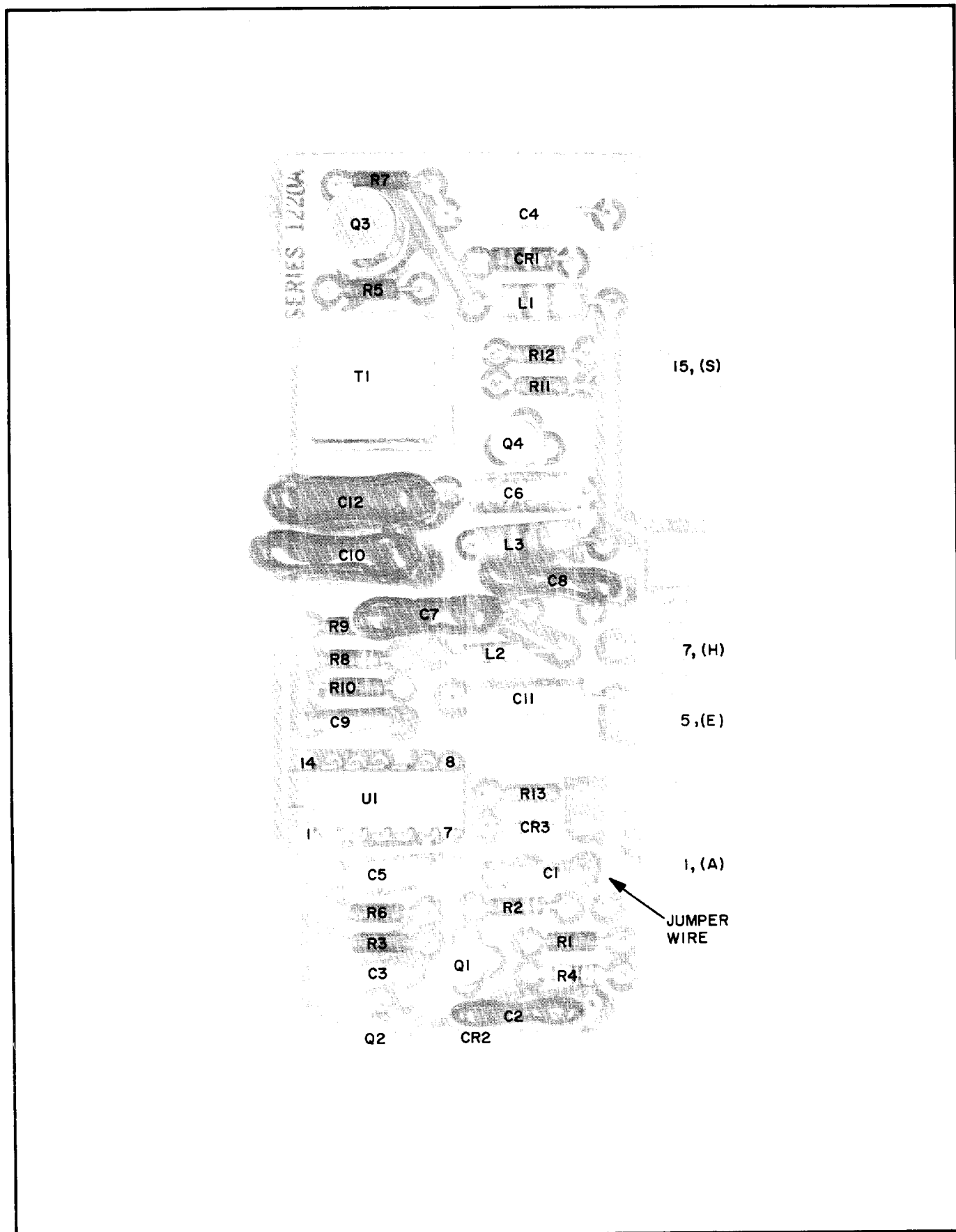

Part of Figure 8-6. A7 1.0 MHz to 100.0 kHz Divider Board

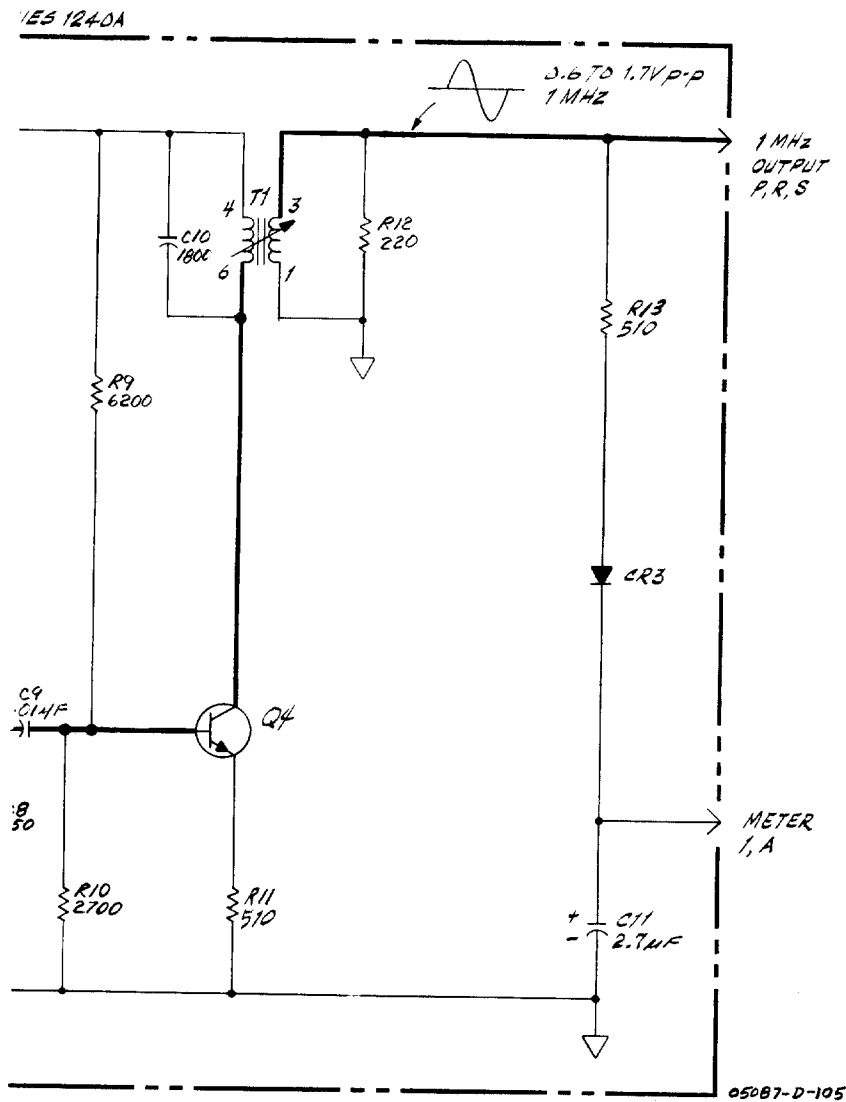

NOTES

1. REFERENCE DESIGNATIONS WITHIN THIS ASSEMBLY ARE ABBREVIATED. ADD ASSEMBLY NUMBER TO ABBREVIATION FOR COMPLETE DESCRIPTION.
2. UNLESS OTHERWISE INDICATED:
RESISTANCE IN OHMS;
CAPACITANCE IN PICO FARADS;
INDUCTANCE IN MICROHENRIES
3. TEST INPUT: 5MHz, 3V RMS
4. MAY BE REMOVED TO GIVE 1000Ω INPUT IMPEDENCE
5. JUMPER WIRE FOR SELECTING INPUT SIGNAL SOURCE. NORMALLY CONNECTED TO PINS 3,C CAN BE CONNECTED TO ANY ONE OF THE THREE INPUTS, DEPENDING ON WHICH ONE CARRIES THE 5MHz SIGNAL.

Figure 8-5. A6 5.0 MHz to 1.0 MHz Divider Board

A7 1MHz TO 100 KHz

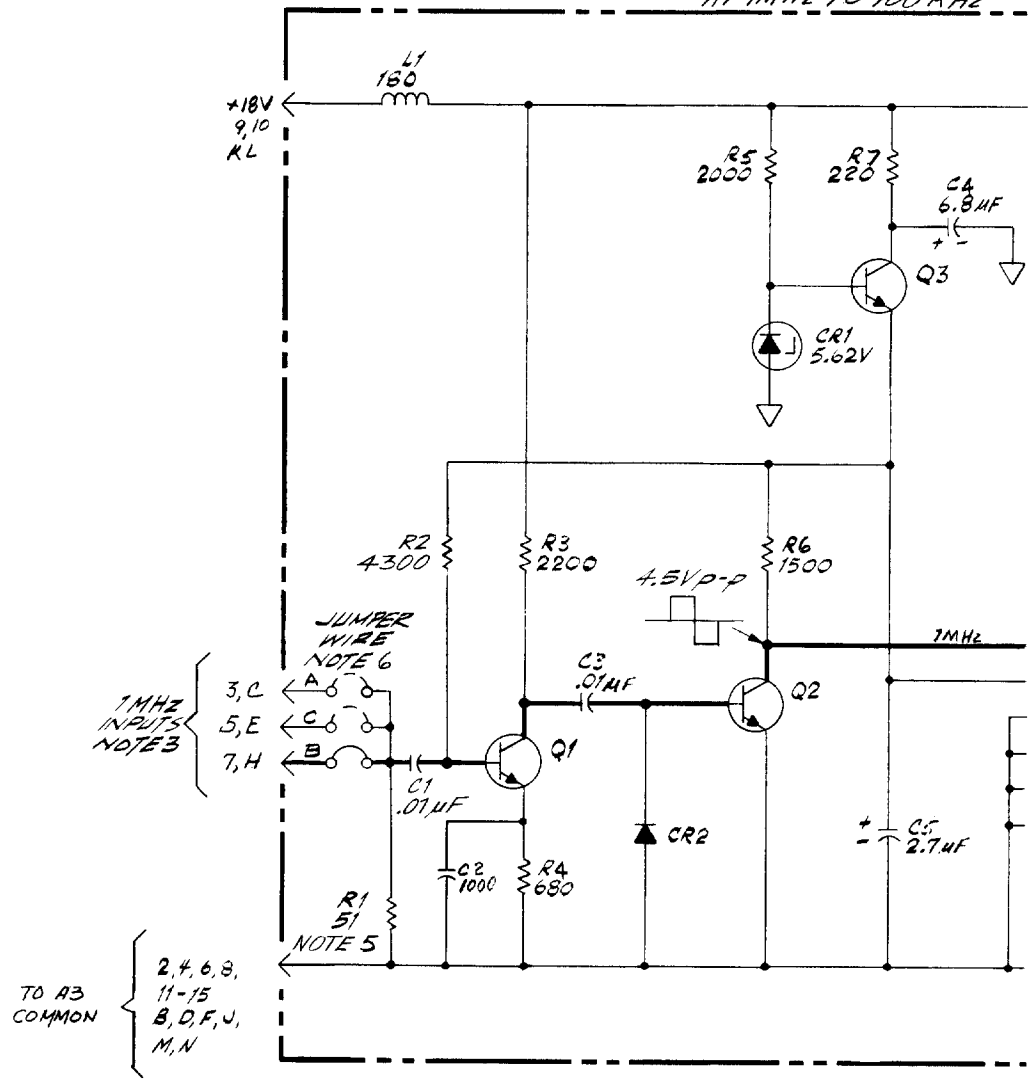

NOTES

1. REFERENCE DESIGNATIONS WITHIN THIS ASSEMBLY ARE ABBREVIATED. ADD ASSEMBLY NUMBER TO ABBREVIATION FOR COMPLETE DESCRIPTION.
2. UNLESS OTHERWISE INDICATED: RESISTANCE IN OHMS; CAPACITANCE IN PICOFARADS; INDUCTANCE IN MICROHENRIES
3. TEST INPUT: 1MHz, 1V RMS.
4. TWO ACCEPTABLE DISPLAYS POSSIBLE.
5. MAY BE REM IMPEDANCE.
6. JUMPER WIR. SIGNAL SOUR TO PINS 5, E. ANY ONE OF DEPENDING O THE 1MHz SIC

COMPONENT LOCATOR FOR A8, A9, A10 & A12

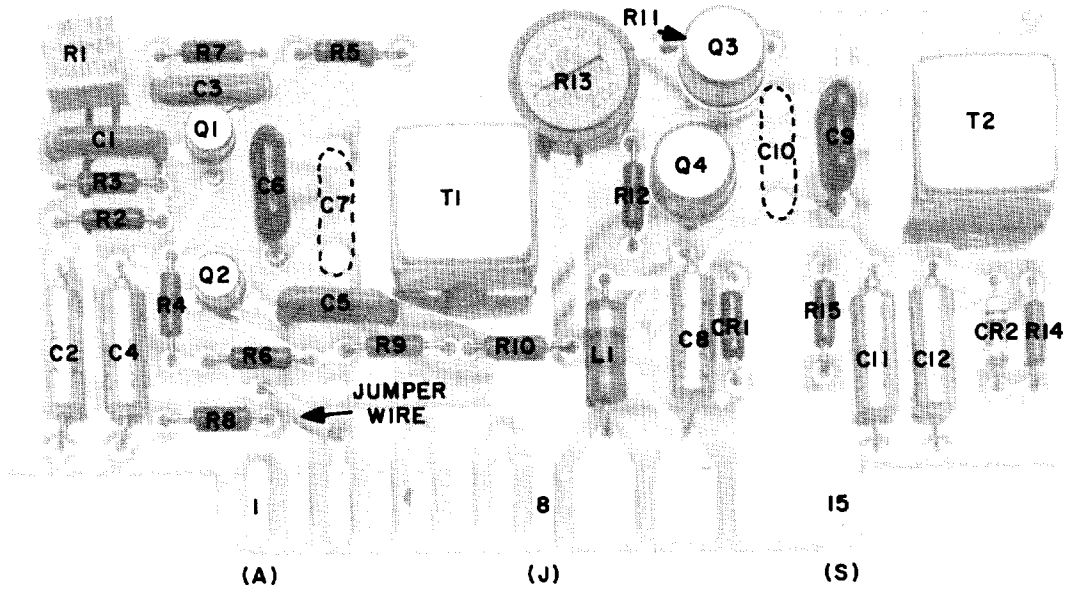

Part of Figure 8-7.

DIVIDER BOARD ASSEMBLY (05087-60006) SERIES 1240A

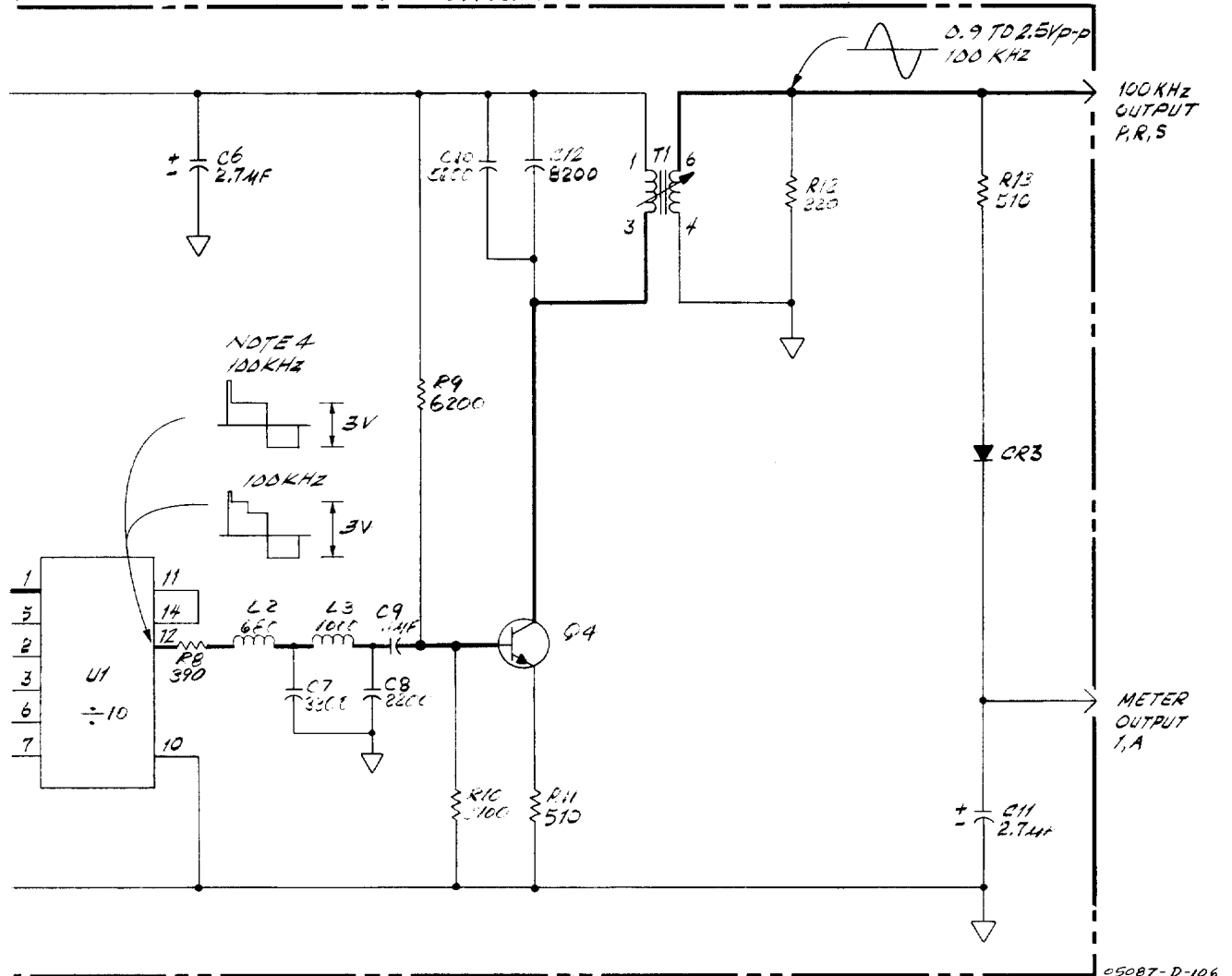

OVED TO GIVE 1000 Ω

E FOR SELECTING INPUT
CE, NORMALLY CONNECTED
CAN BE CONNECTED TO
THE THREE INPUTS
N WHICH ONE CARRIES
IGNAL.

Figure 8-6. A7 1.0 MHz to 100.0 kHz Divider Board

AB 5MHz AMPLIFIER

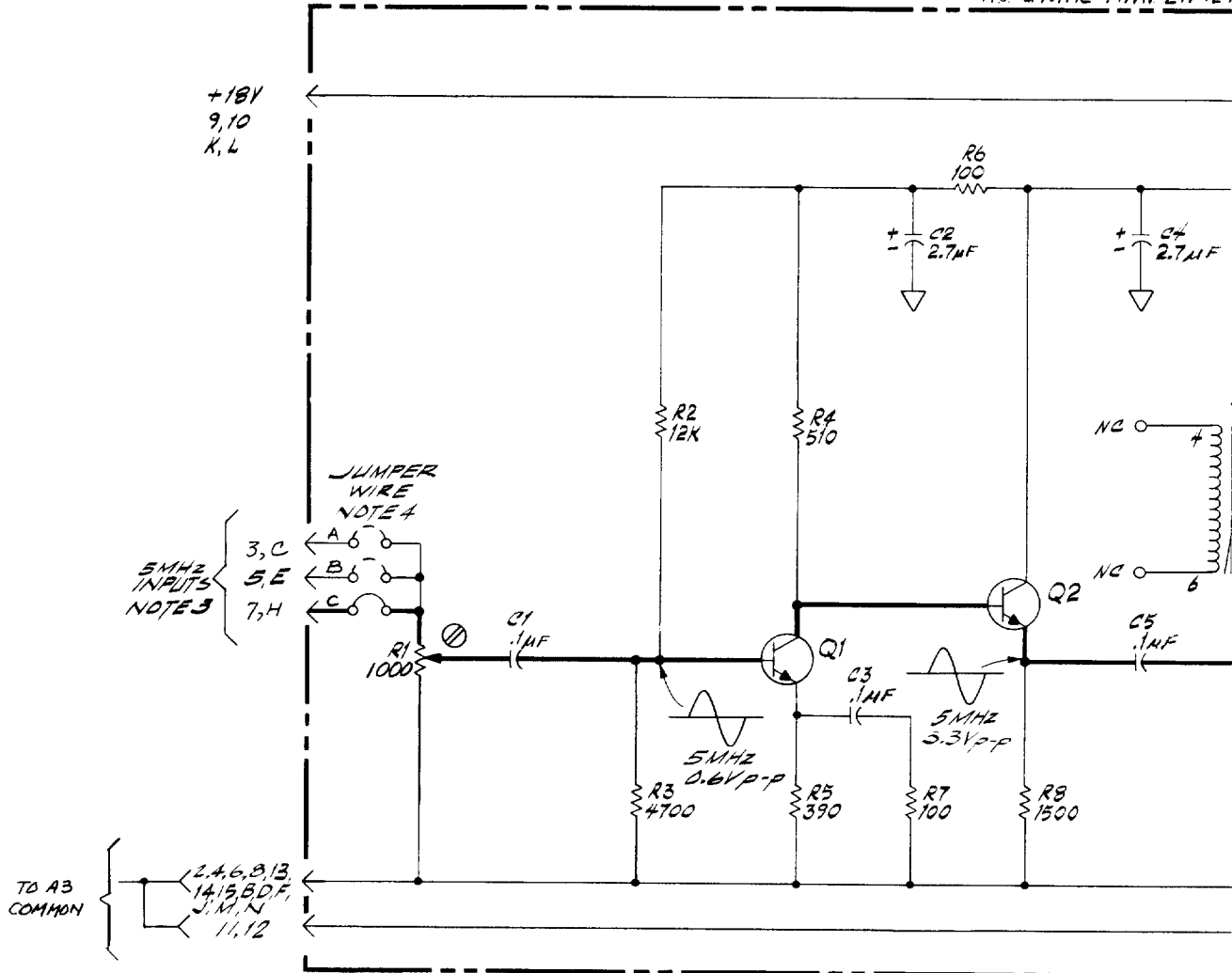

NOTES

1. REFERENCE DESIGNATIONS WITHIN THIS ASSEMBLY ARE ABBREVIATED. ADD ASSEMBLY NUMBER TO ABBREVIATION FOR COMPLETE DESCRIPTION.
2. UNLESS OTHERWISE INDICATED:
RESISTANCE IN OHMS;
CAPACITANCE IN PICOFARADS;
INDUCTANCE IN MICROHENRIES
3. TEST INPUT : 5 MHz, 1V RMS
4. JUMPER WIRE FOR SELECTING INPUT SIGNAL SOURCE. NORMALLY CONNECTED TO PINS 3, C. CAN BE CONNECTED TO ANY ONE OF THE THREE INPUTS, DEPENDING ON WHICH ONE CARRIES THE 5 MHz SIGNAL.

R BOARD ASSEMBLY (05087-60001) SERIES 124DA

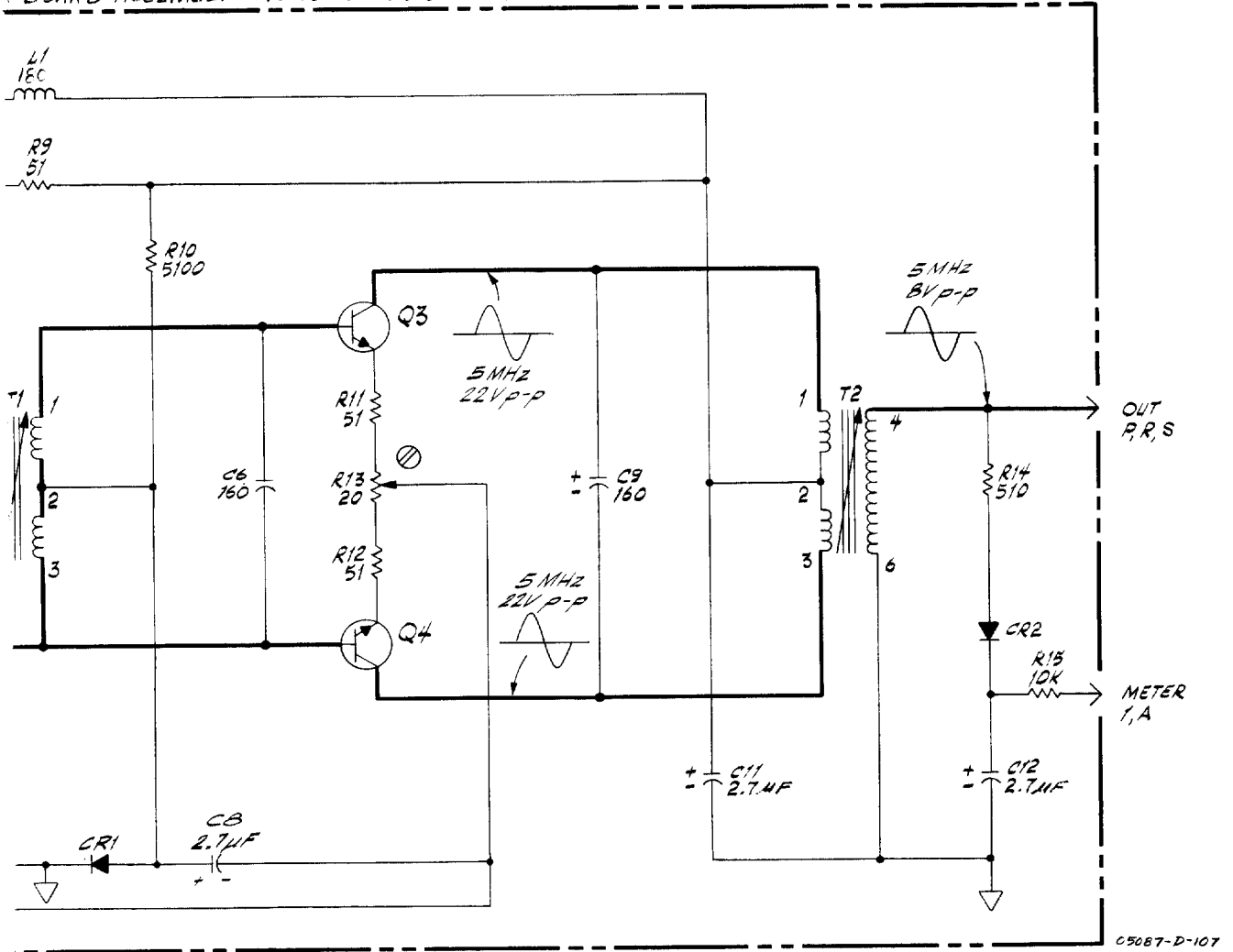
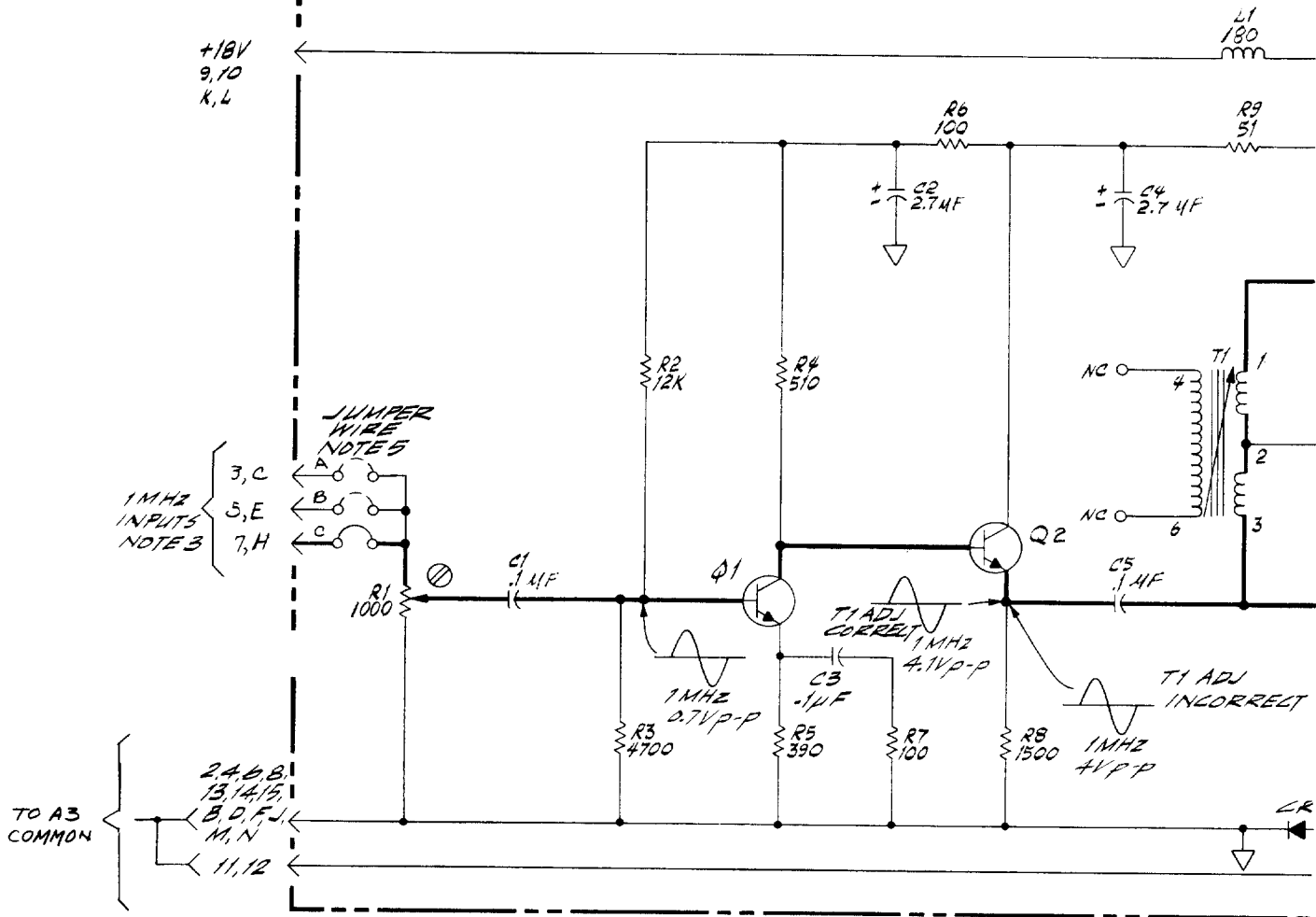

Figure 8-7. A8 5.0 MHz Amplifier Board

A9 1MHz AMPLIFIER B



NOTES

1. REFERENCE DESIGNATIONS WITHIN THIS ASSEMBLY ARE ABBREVIATED. ADD ASSEMBLY NUMBER TO ABBREVIATION FOR COMPLETE DESCRIPTION.
2. UNLESS OTHERWISE INDICATED:
RESISTANCE IN OHMS;
CAPACITANCE IN PICOFARADS;
INDUCTANCE IN MICROHENRIES
3. TEST INPUT: 1 MHz, 1 V RMS
4. SEE A8 FOR COMPONENT LOCATOR.
5. JUMPER WIRE FOR SELECTING INPUT SIGNAL SOURCE. NORMALLY CONNECTED TO PINS 5, E. CAN BE CONNECTED TO ANY ONE OF THE THREE INPUTS, DEPENDING ON WHICH ONE CARRIES A 1 MHz SIGNAL.

DARD ASSEMBLY (05087-60002) SERIES 1240A

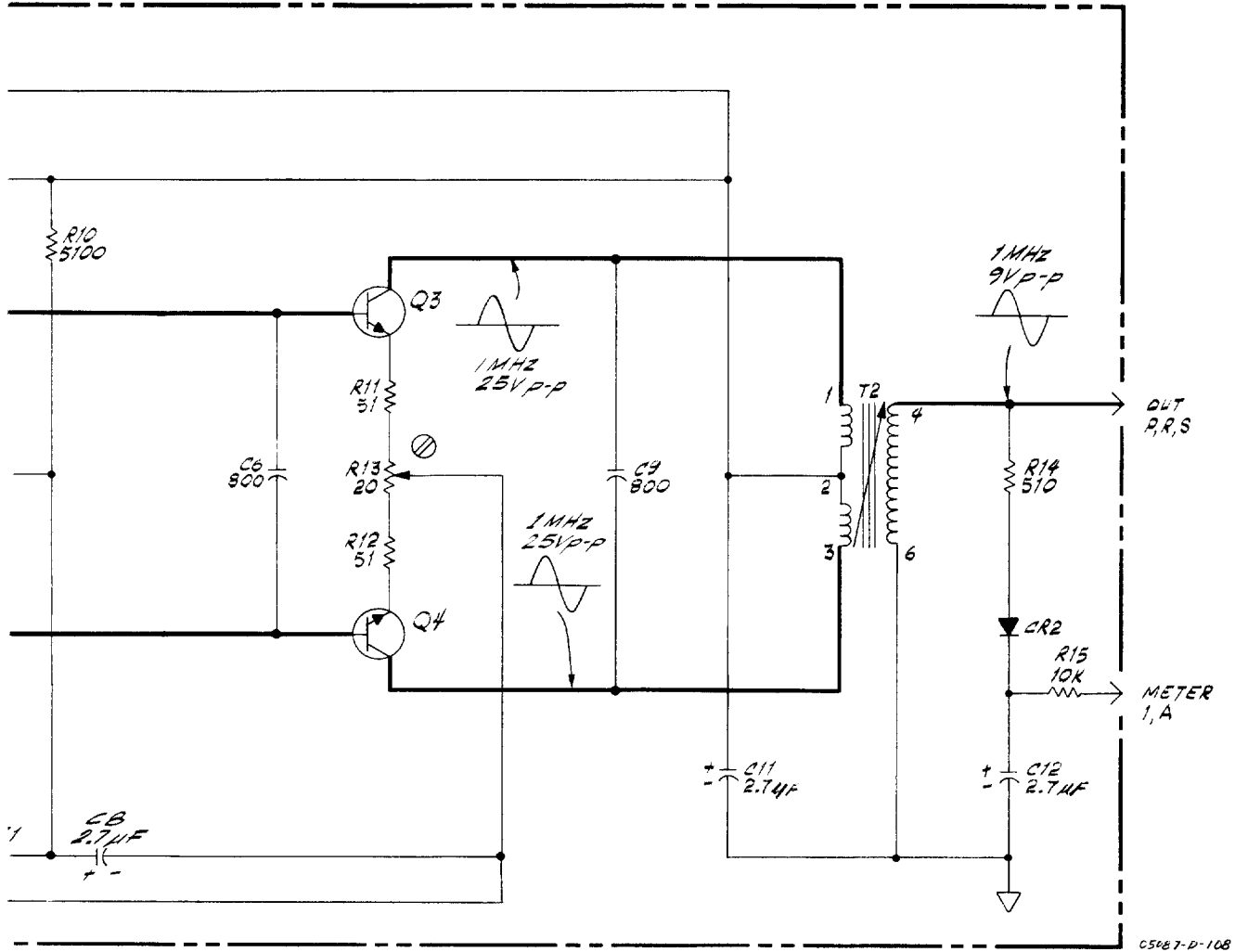
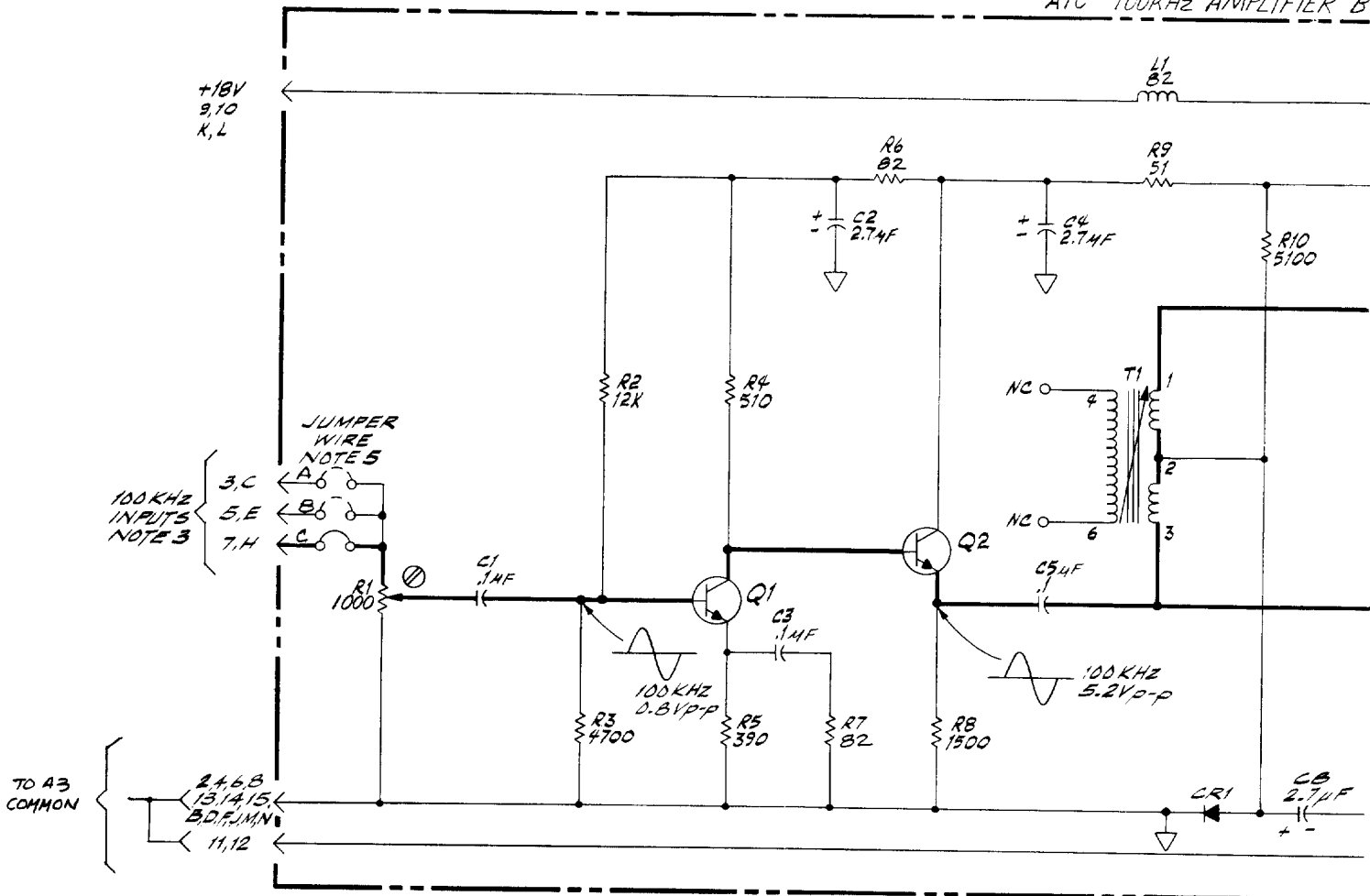

Figure 8-8. A9 1.0 MHz Amplifier Board

AIC 100KHz AMPLIFIER B



NOTES

1. REFERENCE DESIGNATIONS WITHIN THIS ASSEMBLY ARE ABBREVIATED... ADD ASSEMBLY NUMBER TO ABBREVIATION FOR COMPLETE DESCRIPTION.
2. UNLESS OTHERWISE INDICATED:
RESISTANCE IN OHMS;
CAPACITANCE IN PICO FARADS;
INDUCTANCE IN MICROHENRIES
3. TEST INPUT: 100KHz, 1VRMS
4. SEE A8 FOR COMPONENT LOCATOR.
5. JUMPER WIRE FOR SELECTING INPUT SIGNAL SOURCE. NORMALLY CONNECTED TO PINS 7, H. CAN BE CONNECTED TO ANY ONE OF THE THREE INPUTS, DEPENDING ON WHICH ONE CARRIES A 100KHz SIGNAL.

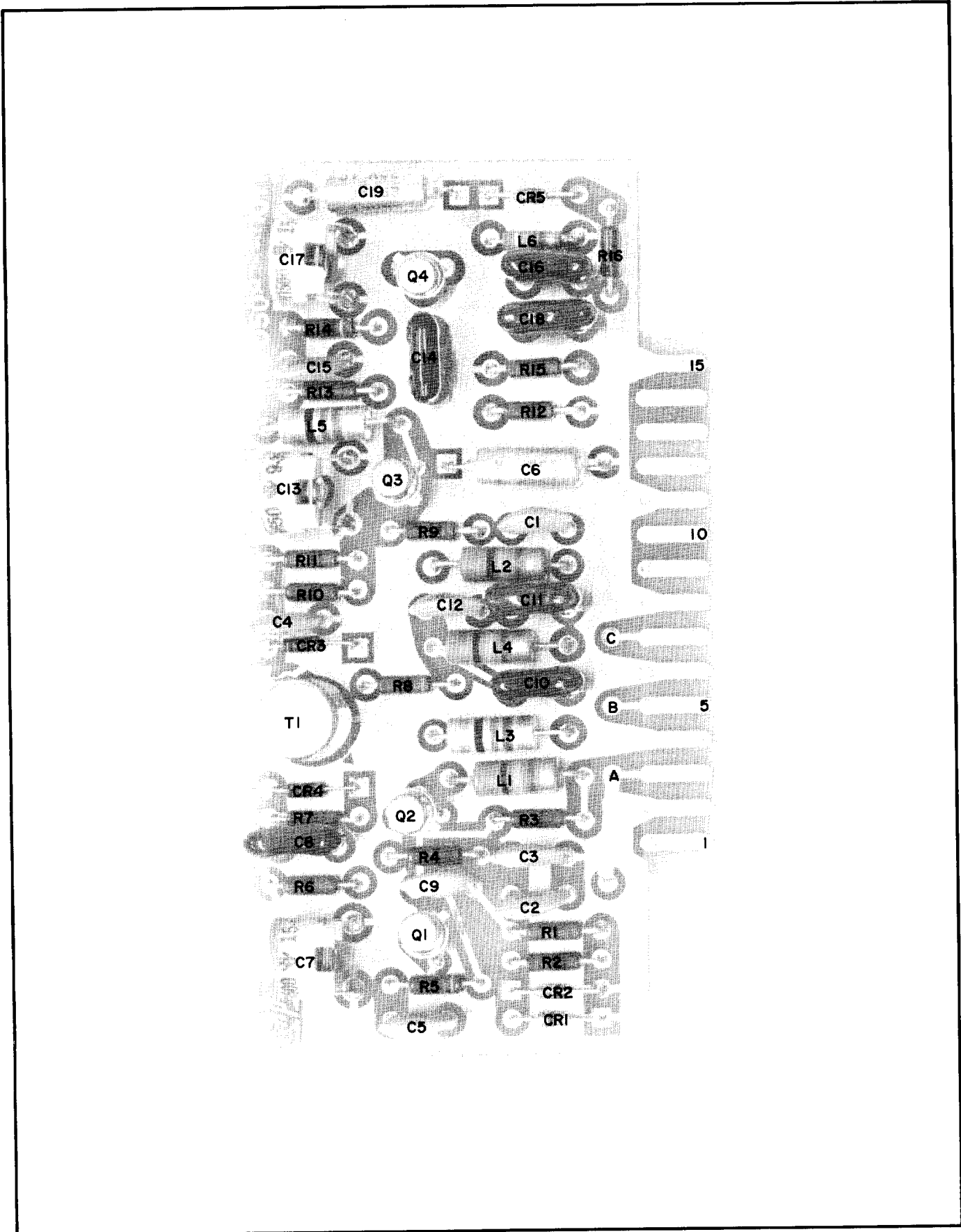

Part of Figure 8-10. A11 5-10 MHz Doubler Assembly

CARD ASSY (05087-60003) SERIES 1240A

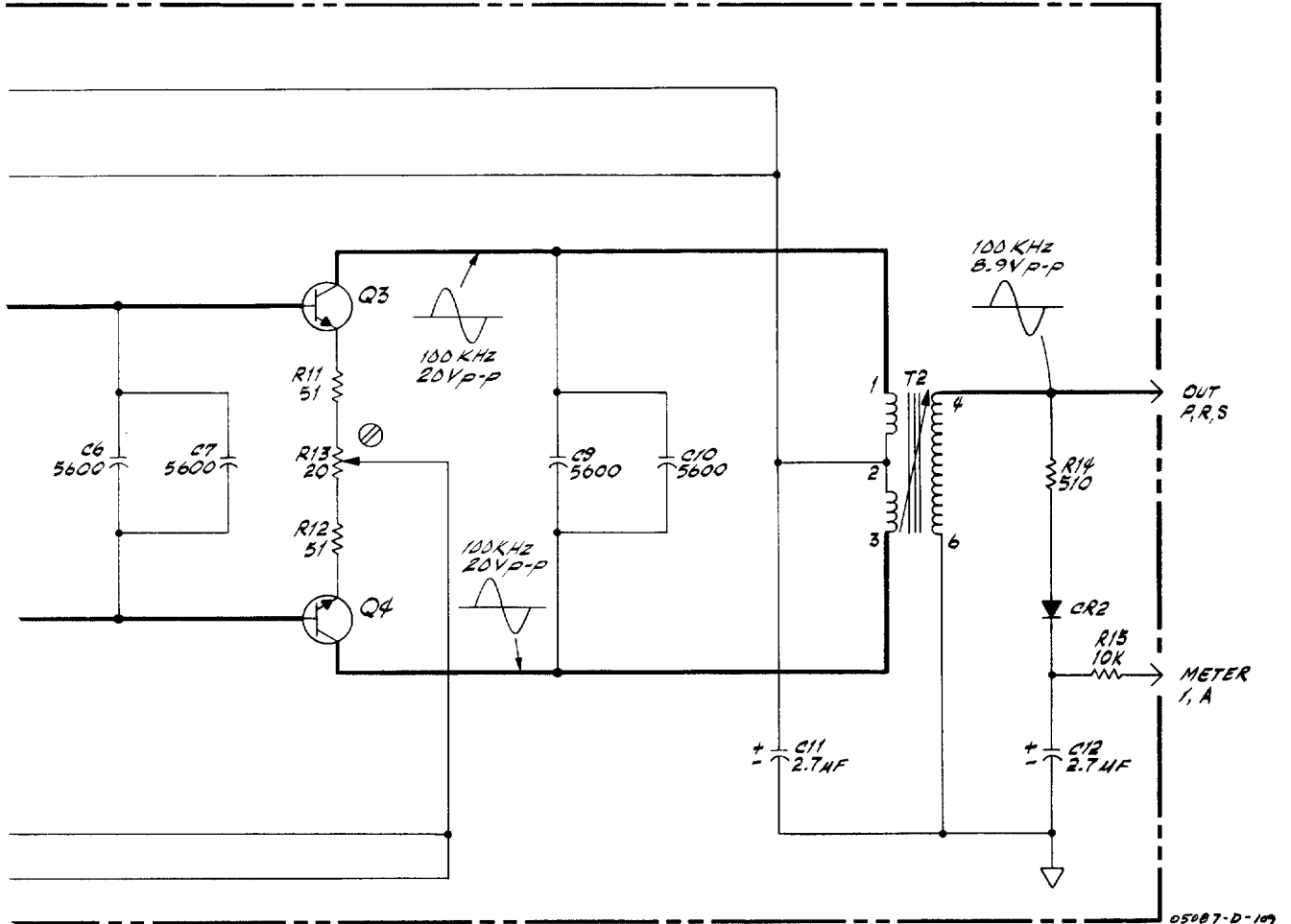
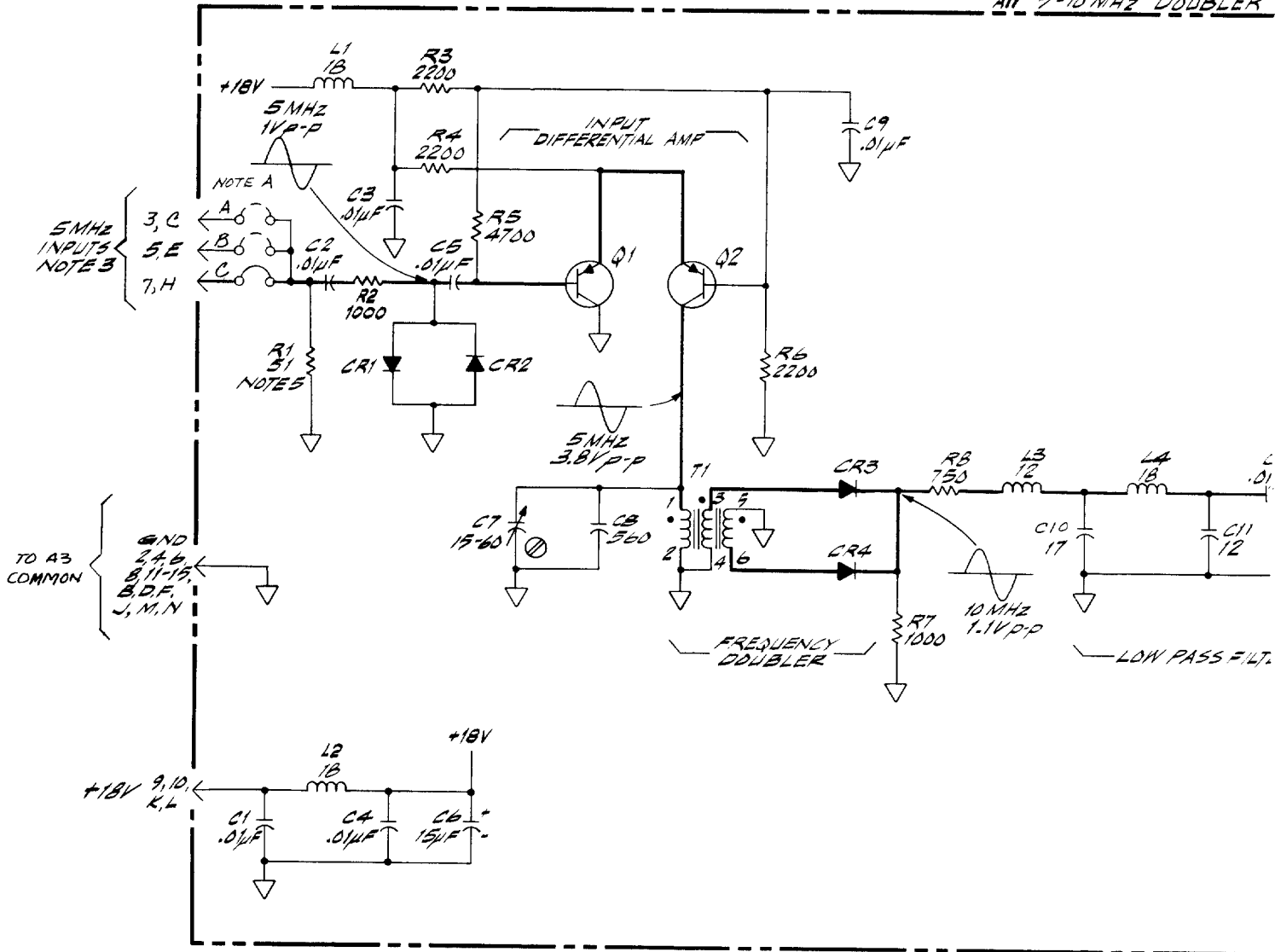

Figure 8-9. A10 100.0 kHz Amplifier Board

ALL 5-10 MHz DOUBLER



NOTES

1. REFERENCE DESIGNATIONS WITHIN THIS ASSEMBLY ARE ABBREVIATED. ADD ASSEMBLY NUMBER TO ABBREVIATION FOR COMPLETE DESCRIPTION.
2. UNLESS OTHERWISE INDICATED:
RESISTANCE IN OHMS;
CAPACITANCE IN PICOFARADS;
INDUCTANCE IN MICROHENRIES
3. TEST INPUT: 5 MHz, 1V RMS
4. JUMPER WIRE FOR SELECTING INPUT SIGNAL SOURCE. NORMALLY CONNECT TO PINS 5, E. CAN BE CONNECTED TO ANY ONE OF THE THREE INPUTS, DEPENDING ON WHICH ONE CARRIES THE 5 MHz SIGNAL.
5. MAY BE REMOVED FOR 1000 Ω INPUT IMPEDANCE.

ASSEMBLY (05087-600(1)) SERIES 1320A

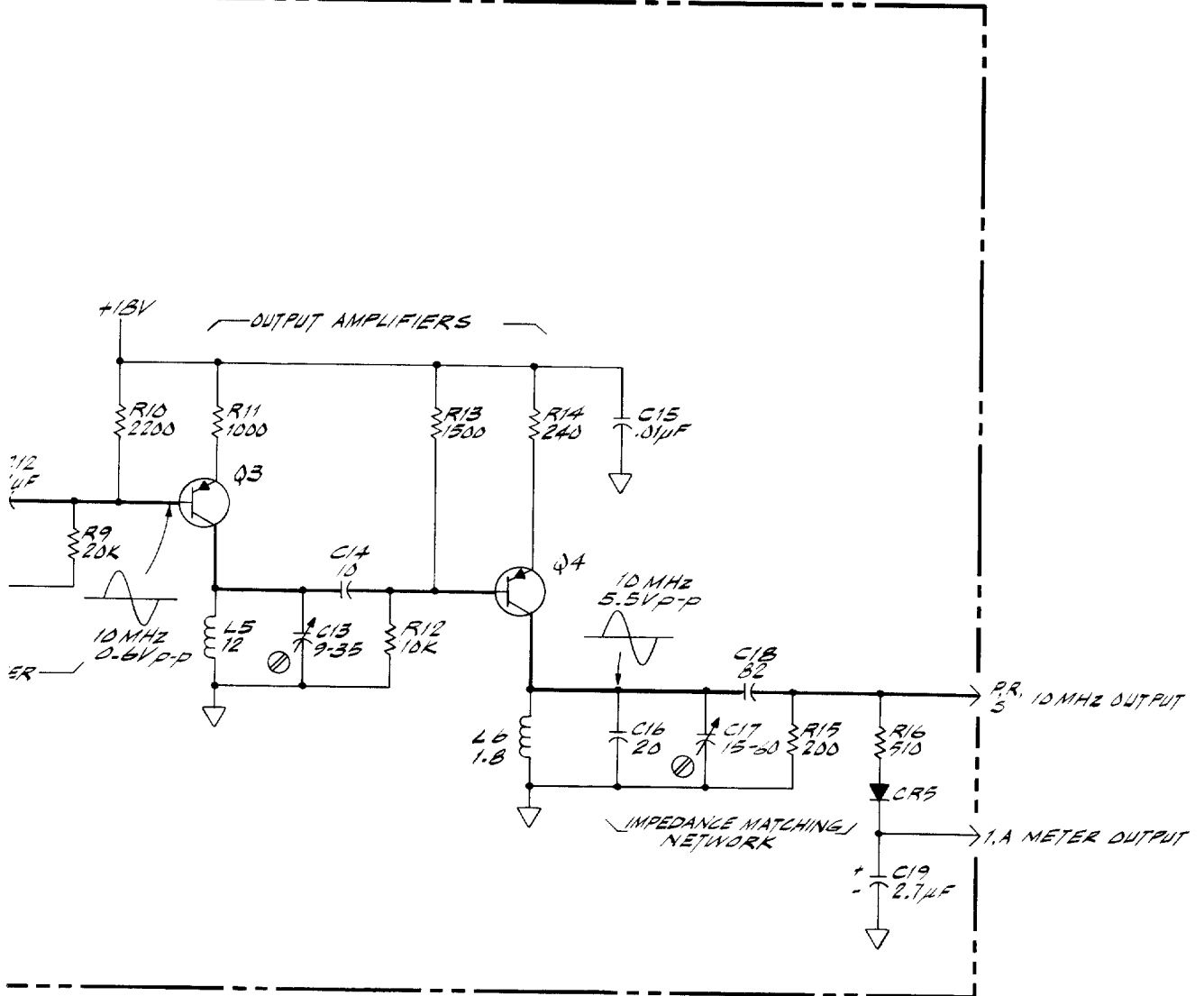

10

Figure 8-10. A11 5-10 MHz Doubler Assembly

A12 10 MHz AMPLIFIER

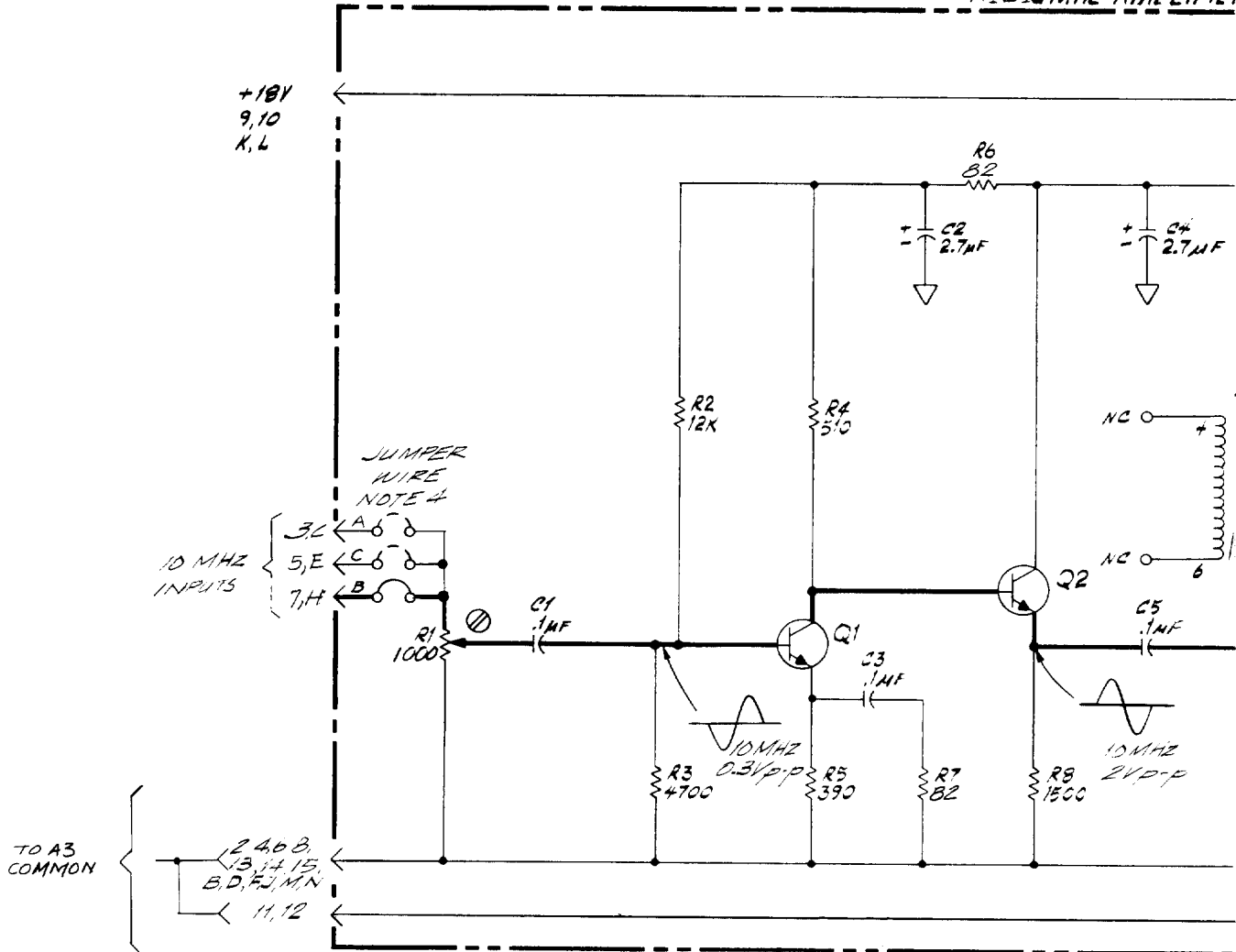

NOTES

1. REFERENCE DESIGNATIONS WITHIN THIS ASSEMBLY ARE ABBREVIATED. ADD ASSEMBLY NUMBER TO ABBREVIATION FOR COMPLETE DESCRIPTION.
2. UNLESS OTHERWISE INDICATED:
RESISTANCE IN OHMS;
CAPACITANCE IN MICROFARADS;
INDUCTANCE IN MICROHENRIES
3. SEE A8 FOR COMPONENT LOCATOR.
- 4.

R BOARD ASSEMBLY (05087-60012) SERIES 1620 (NOTE 3)

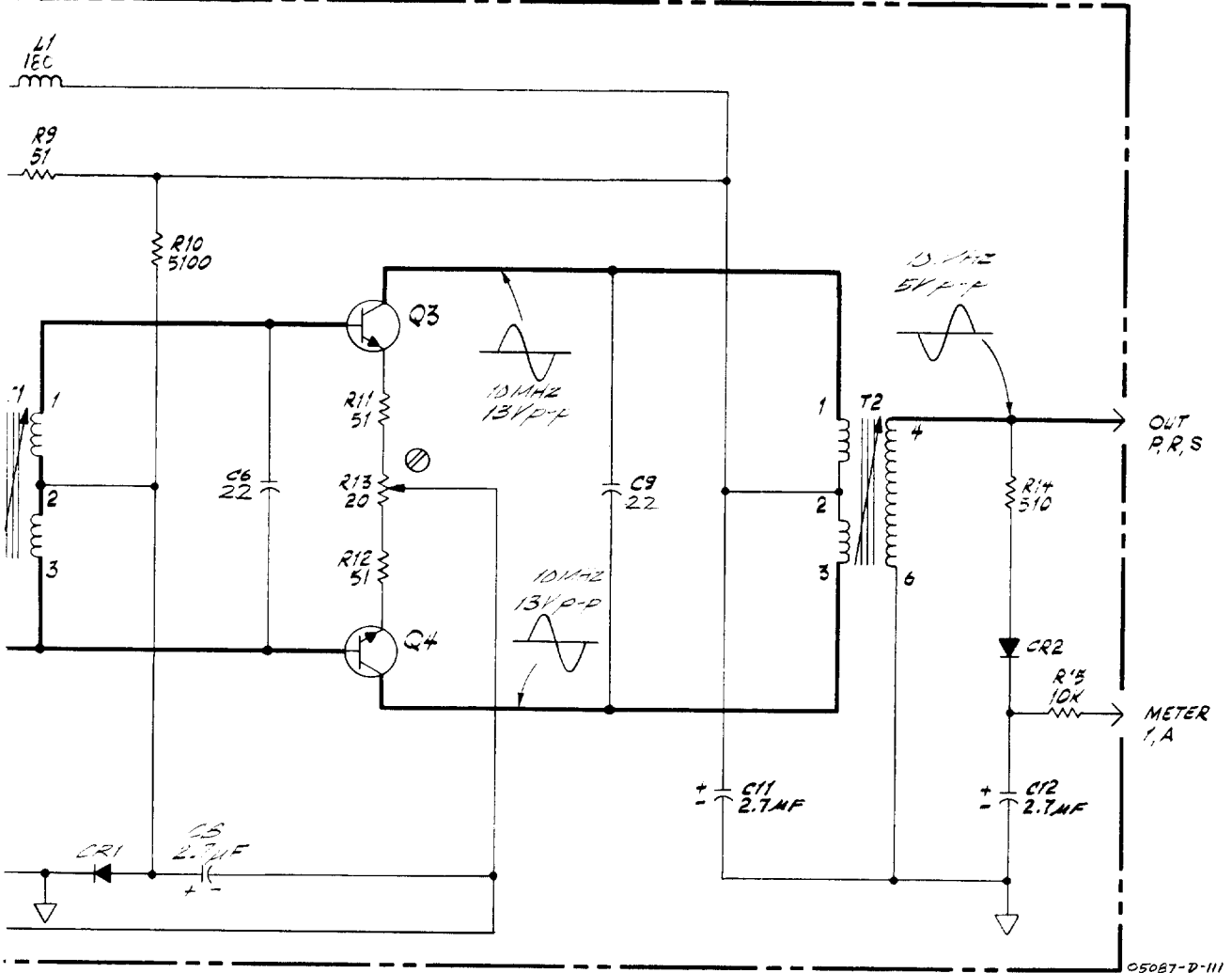

JUMPER WIRE FOR SELECTING INPUT SIGNAL SOURCE. NORMALLY CONNECTED TO PINS 5, E. CAN BE CONNECTED TO ANY OF THE THREE INPUTS, DEPENDING ON WHICH ONE CARRIES THE 10 MHz SIGNAL.

Figure 8-11. A12 10 MHz Amplifier Board

A13 10MHz TO 5MHz DIVIDER BOARD ASSEMBLY (05087-600013) SERIE.

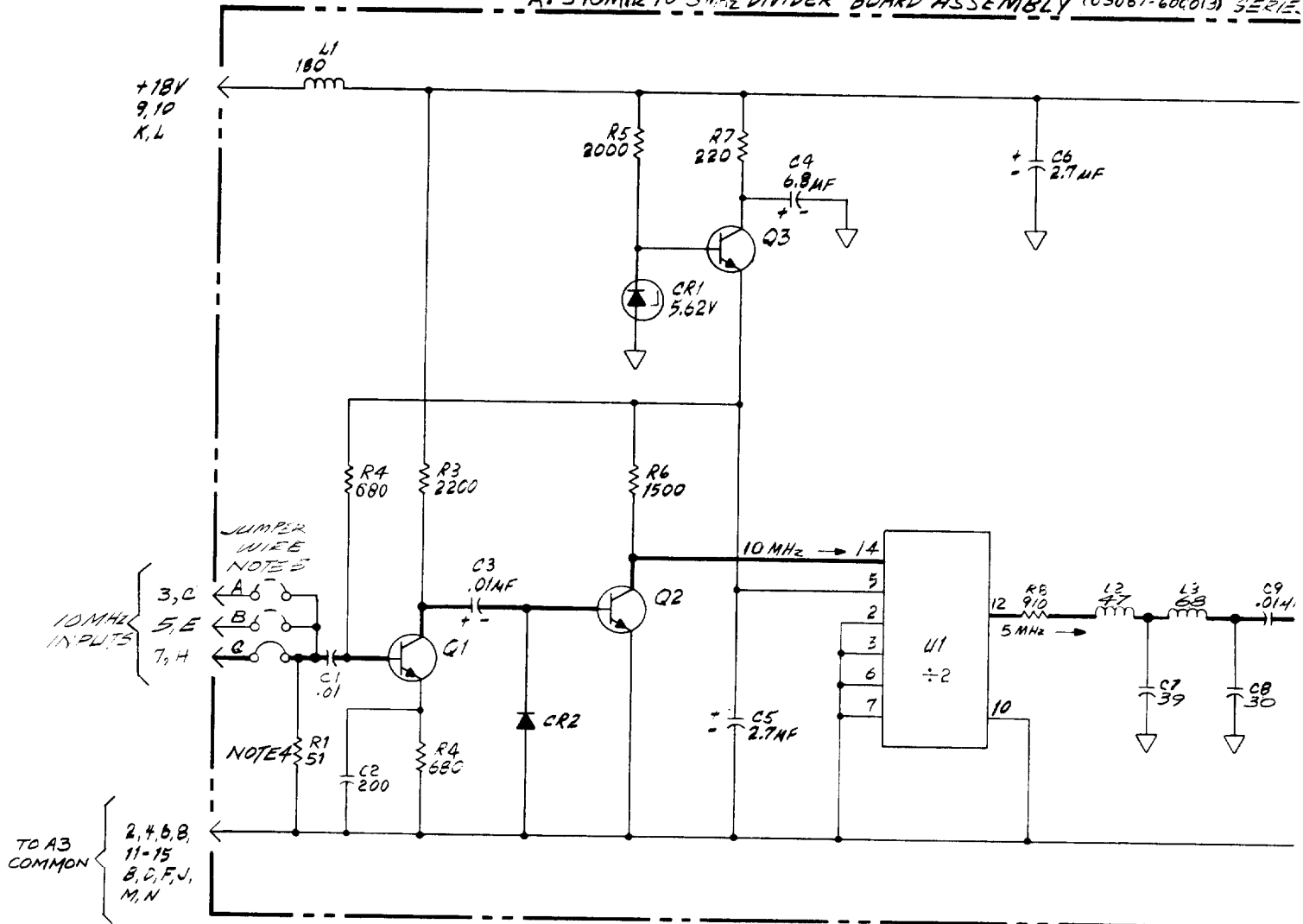

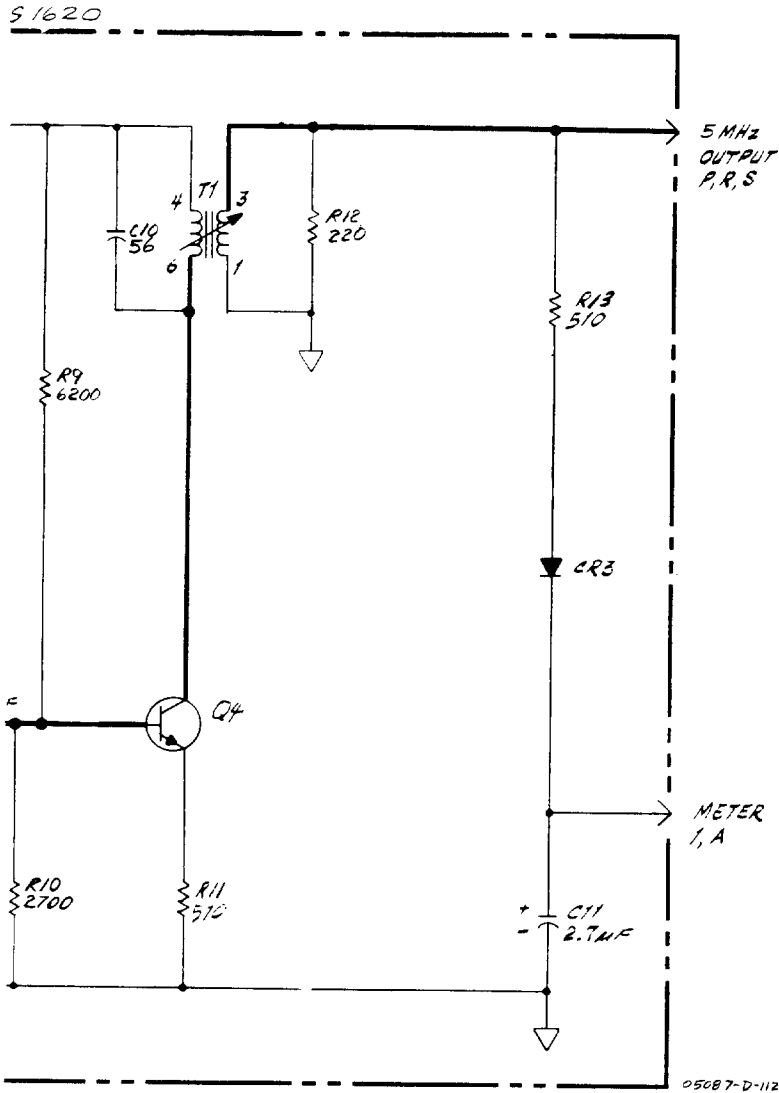

NOTES

1. REFERENCE DESIGNATIONS WITHIN THIS ASSEMBLY ARE ABBREVIATED. ADD ASSEMBLY NUMBER TO ABBREVIATION FOR COMPLETE DESCRIPTION.
2. UNLESS OTHERWISE INDICATED:
RESISTANCE IN OHMS;
CAPACITANCE IN PICOFARADS;
INDUCTANCE IN MICROHENRIES
3. SEE A6 FOR COMPONENT LOCATOR.
4. MAY BE REMOVED TO GIVE 1000Ω INPUT IMPEDANCE.
5. JUMPER WIRE FOR SELECTING INPUT SIGNAL SOURCE. NORMALLY CONNECTED TO PINS 3, C. MAY BE CONNECTED TO ANY ONE OF THE THREE INPUTS, DEPENDING ON WHICH ONE CARRIES THE 10 MHz SIGNAL.

Figure 8-12. A13 10 MHz to 5.0 MHz Divider Board

A14. 10 MHz TO 1 MHz DIVIDER BOARD ASSEMBLY (05087-60014) SET

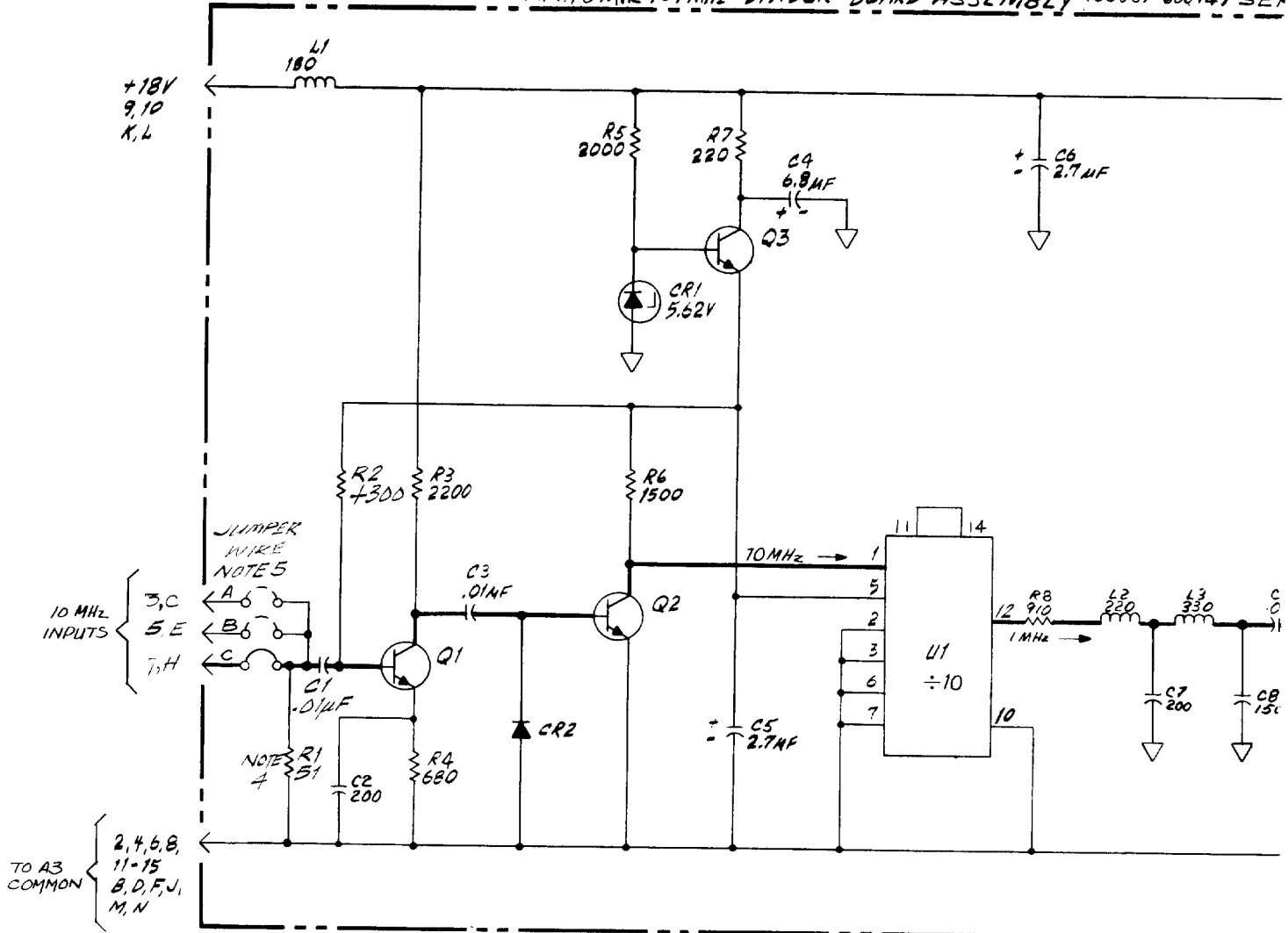

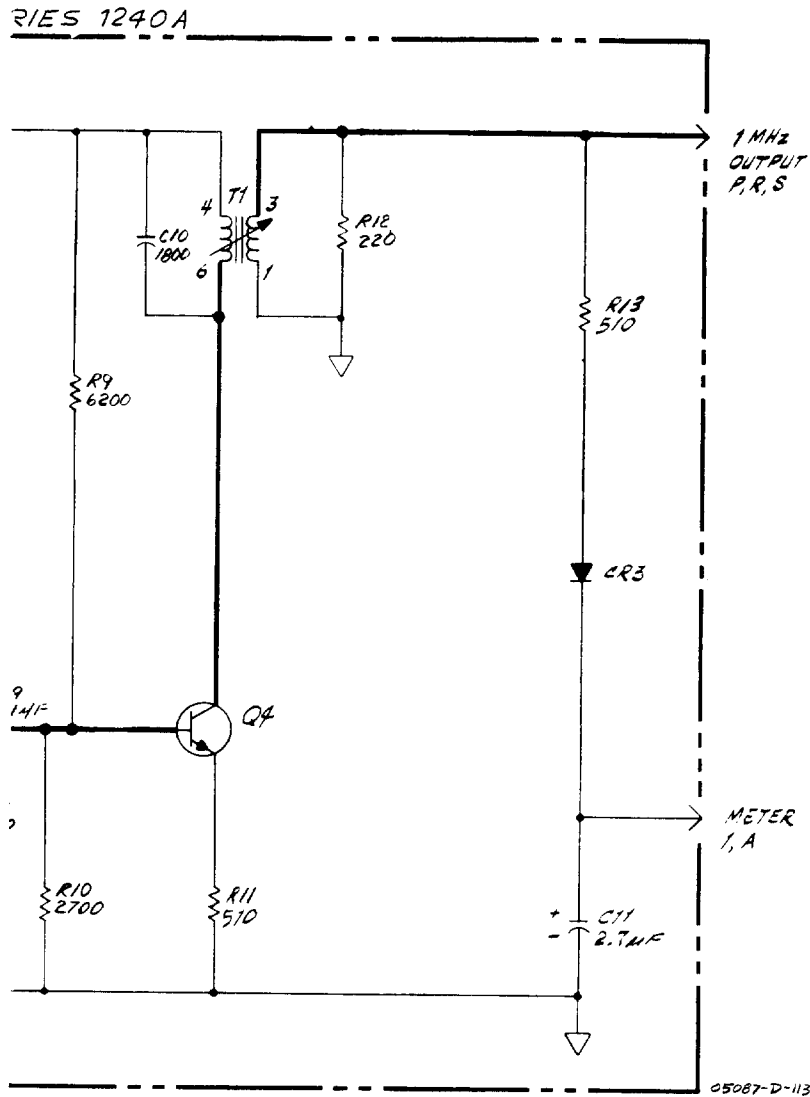

NOTES

1. REFERENCE DESIGNATIONS WITHIN THIS ASSEMBLY ARE ABBREVIATED. ADD ASSEMBLY NUMBER TO ABBREVIATION FOR COMPLETE DESCRIPTION.
2. UNLESS OTHERWISE INDICATED:
RESISTANCE IN OHMS;
CAPACITANCE IN PICOFRADS;
INDUCTANCE IN MICROHENRIES
3. SEE A6 FOR COMPONENT LOCATOR.
4. MAY BE REMOVED TO GIVE 1000Ω INPUT IMPEDANCE.
5. JUMPER WIRE FOR SELECTING INPUT SIGNAL SOURCE. NORMALLY CONNECTED TO PINS 3, C. MAY BE CONNECTED TO ANY ONE OF THE THREE INPUTS, DEPENDING ON WHICH ONE CARRIES THE 10 MHz SIGNAL

Figure 8-13. A14 10 MHz to 1.0 MHz Divider Board

APPENDIX A

MANUAL CHANGES AND OPTIONS

A-1. MANUAL CHANGES

A-2. This manual applies directly to Model 5087A Distribution Amplifier having serial number prefix 1620A.

A-3. NEWER INSTRUMENTS

A-4. As changes are made, newer instruments may have serial number prefixes not listed in this manual. The manuals for these instruments will be supplied with an additional "manual changes" sheet containing the required information; contact the nearest Hewlett-Packard Sales and Service Office for information if this sheet is missing.

A-5. OLDER INSTRUMENTS

A-6. This manual with changes listed in Table A-1 applies to Model 5087A Distribution Amplifier having serial number prefix below 1620A.

A-7. OPTIONS

A-8. There are four normal configurations available, which are listed as Options 031, 032, 033, and 034. These options consist of:

- a. Option 031: One each, 5 MHz, 1 MHz, and 100 kHz Input Preamplifiers and four each, 5 MHz, 1 MHz, and 100 kHz Output Amplifiers.
- b. Option 032: A single 5 MHz Input Preamplifier and twelve, 5 MHz Output Amplifiers.
- c. Option 033: A single 10 MHz Input Preamplifier and twelve, 10 MHz Output Amplifiers.
- d. Option 034: A single 5 MHz Input Preamplifiers and four each, 5 MHz, 1 MHz, and 100 kHz Output Amplifiers.

A-9. In addition to the four available, normal configurations, which are listed by option number, each printed circuit assembly which can be installed in INPUT A, B, C positions or Output 1 to 12 positions is assigned an option number. For example: INPUT A, C, C positions can have the following options installed (up to 3 total):

Option 004 is Input Preamplifier (100 kHz to 10 MHz).
Option 005 is 5 MHz to 1 MHz Input Divider.
Option 006 is 1 MHz to 100 kHz Input Divider.
Option 011 is 5 MHz to 10 MHz Input Doubler.
Option 013 is 10 MHz to 5 MHz Input Divider.
Option 014 is 10 MHz to 1 MHz Input Divider.

A-10. Outputs 1 to 12 positions can have the following options installed (up to 12 total):

Option 001 is 5 MHz Output Amplifier.
Option 002 is 1 MHz Output Amplifier.
Option 003 is 100 kHz Output Amplifier.
Option 012 is 10 MHz Output Amplifier.

A-11. Configurations which are not like Option 031 to Option 034 can be made up on special order by indicating the option number to be installed in each of the printed circuit board sockets.

Table A-1. Changes for Older Instruments

Instrument Prefix and Serial Number	Make Changes Number
1220A or 1240A	1, 2
1320A	2

CHANGE 1

Figure 8-9, A11 Assembly: Change C8 to 470.
 Table 6-2, A11 Assembly: Change A11C8 from 0140-0178 to 0140-0149, C:FXD MICA 470 PF, Mfg. Code 72136, Mfr. Number DM15F471J3S.
 Figure 8-4, A5 Assembly: Use Figure A-1 in place of Figure 8-4.
 Table 6-2, A5 Assembly: Change A5C2 to 0180-1117, Qty 1, C:FXD ELECT 3.7 UF., Mfr. Number 0180-1746.
 Change A5CR1 to 1901-0040, DIODE:GE, 60 MA, 60V, Mfr. Code 07263, Mfr. Number FDG1088.
 Change A5L1 to A5L2. Add A5L1, 9140-0138, Qty 1, COIL, 180 UF, 5%, Mfr. Code 28480, Mfr. Number 9140-0138.
 Change A5R4 and A5R5 to 0757-0941, R:FXD FLM 5.1K, Mfr. Part Number 0757-0941.
 Change A5R6 to 0757-0917, R:FXD FLM, 510 OHM, Mfr. Number 0757-0917.
 Delete A5R8.

CHANGE 2

Page 6-4, Table 6-2, Replaceable Parts:
 Change A3 to 05087-60007; BOARD ASSY: MOTHER (SERIES 1240A); 28480; 05087-60007.
 Change W3, W4, and W5 to 05087-60021 in HP and Mfr. Part Number columns.
 Change W12 through W14 to 05087-60022 in HP and Mfr Part Number columns.
 Change W15, W16, and W17 to 05087-60023 in HP and Mfr. Part Number columns.

Page 6-5, Table 6-2, Replaceable Parts:
 Change A3 to 05087-60007; BOARD ASSY: MOTHER (SERIES 1240A).

Page 6-9, Table 6-2, Replaceable Parts:
 Change A12 to SERIES 1240A.
 Change A12C6 and A12C9 to 0160-2150; C:FXD MICA 33 PF 5% 300 VDCW; 28480; 0160-2150.

Page 6-10, Table 6-2, Replaceable Parts:
 Change A13 to SERIES 1240A.
 Change A13C10 to 0160-0188; C:FXD MICA 53 PF 5% 300 VDCW; 28480; 0160-0188.

Page 8-25, Figure 8-11, A12 Schematic Diagram:
 Change series number, at top of A12 diagram to 1240A.
 Change A12C6 and A12C9 to 33 pF.

Page 8-27, Figure 8-12, A13 Schematic Diagram:
 Change series number, at top of A13 diagram to 1240A.
 Change A13C10 to 53 pF.

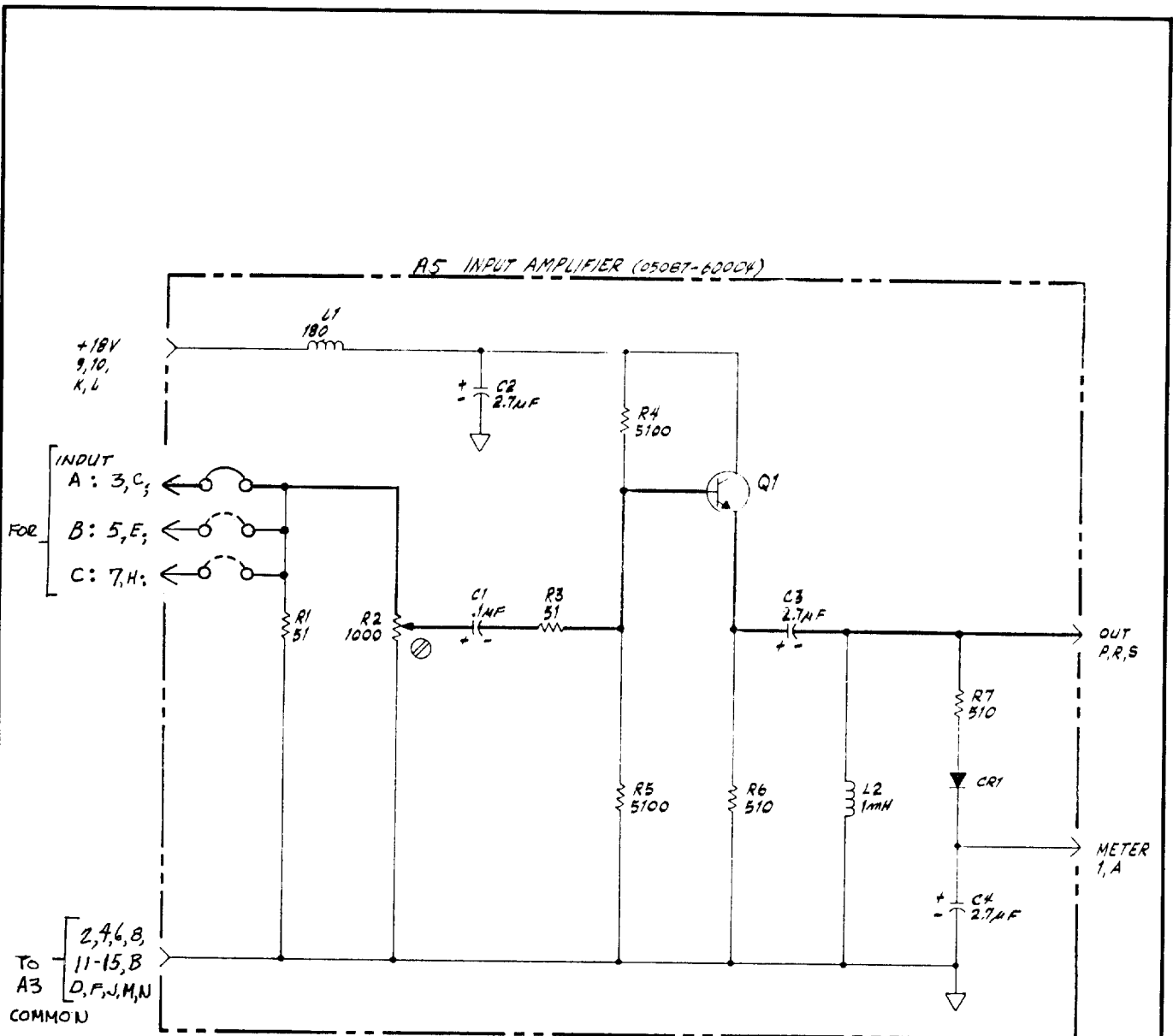

NOTES

1. REFERENCE DESIGNATIONS WITHIN THIS ASSEMBLY ARE ABBREVIATED. ADD ASSEMBLY NUMBER TO ABBREVIATION FOR COMPLETE DESCRIPTION.
2. UNLESS OTHERWISE INDICATED:
RESISTANCE IN OHMS;
CAPACITANCE IN PICOFARADS;
INDUCTANCE IN MICROHENRIES

REFERENCE DESIGNATION

AS
C1-4
CR1
L1,2
Q1
R1-7

Figure A-1. A5 Input Amplifier (05087-60004) Series 1240A